

# JVC

# SCHEMATIC DIAGRAMS

## TV/DVD COMBO

# AV-20FD23

CD-ROM No. SML200206

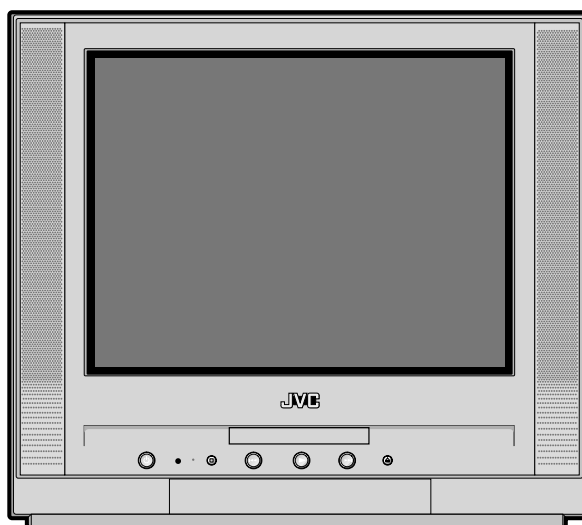
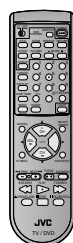

# AV-20FD23 STANDARD CIRCUIT DIAGRAM

## ■ NOTE ON USING CIRCUIT DIAGRAMS

### 1.SAFETY

The Components identified by the symbol  $\triangle$  are critical for safety. For continued safety, replace safety critical components only with manufacturer's recommended parts.

### 2.INDICATION OF PARTS SYMBOL [EXAMPLE]

●In the PC board :R1209→R209

### 3.NOTE FOR REPAIRING SERVICE

This model's power circuit is partly different in the GND.

Please, care must be taken for the following points.

(1)Do not touch the LIVE side GND or the LIVE side GND and the ISOLATED(NEUTRAL) side GND simultaneously. If the above caution is not respected, an electric shock may be caused. Therefore, make sure that the power cord is surely removed from the receptacle when, for example, the chassis is pulled out.

(2)Do not short between the LIVE side GND and ISOLATED(NEUTRAL) side GND or never measure with a measuring apparatus ( oscilloscope, etc.) the LIVE side GND and ISOLATED(NEUTRAL) side GND at the same time. If the above precaution is not respected , a fuse or any parts will be broken.







◇ Since the circuit diagram is a standard one, the circuit and circuit constants may be subject to change for improvement without any notice.

## CONTENTS

<b>SEMICONDUCTOR BASE CONNECTIONS .....</b>	<b>2-2</b>
<b>BLOCK DIAGRAMS .....</b>	<b>2-5</b>
<i>DVD FRONT/BACK END BLOCK DIAGRAM</i>	
<i>TV BLOCK DIAGRAM</i>	
<i>POWER BLOCK DIAGRAM</i>	
<b>WIRING CONNECTION DIAGRAM .....</b>	<b>2-11</b>
<b>SCHEMATIC DIAGRAMS .....</b>	<b>2-13</b>
<i>DVD PCB MPEG SCHEMATIC DIAGRAM</i>	
<i>DVD PCB MEMORY SCHEMATIC DIAGRAM</i>	
<i>DVD PCB SYSCON 1 SCHEMATIC DIAGRAM</i>	
<i>DVD PCB DSP SCHEMATIC DIAGRAM</i>	
<i>DVD PCB MOTOR DRIVE SCHEMATIC DIAGRAM</i>	
<i>DVD PCB READ CHANNEL SCHEMATIC DIAGRAM</i>	
<i>DVD PCB AUDIO/VIDEO SCHEMATIC DIAGRAM</i>	
<i>AV PCB REGULATOR SCHEMATIC DIAGRAM</i>	
<i>AV PCB MICON/TUNER SCHEMATIC DIAGRAM</i>	
<i>AV PCB VIF/SIF/CHORMA SCHEMATIC DIAGRAM</i>	
<i>AV PCB SOUND AMP SCHEMATIC DIAGRAM</i>	
<i>AV PCB I/O SCHEMATIC DIAGRAM</i>	
<i>AV PCB AV SW SCHEMATIC DIAGRAM</i>	
<i>AV PCB COMB FILTER SCHEMATIC DIAGRAM</i>	
<i>AV PCB STEREO SCHEMATIC DIAGRAM</i>	
<i>AV PCB DEFLECTION SCHEMATIC DIAGRAM</i>	
<i>CRT PCB SCHEMATIC DIAGRAM</i>	
<i>POWER PCB SCHEMATIC DIAGRAM</i>	
<i>OPERATION PCB SCHEMATIC DIAGRAM</i>	
<b>PATTERN DIAGRAMS .....</b>	<b>2-51</b>
<i>DVD PCB PATTERN</i>	
<i>AV/CRT PCB PATTERN</i>	
<i>POWER PCB PATTERN</i>	
<b>WAVEFORMS .....</b>	<b>2-59</b>



## SEMICONDUCTOR BASE CONNECTIONS

### DIODE

					
1N4937 1SS133 1SS133T-77 MTZJ11B T-77 MTZJ12B T-77 MTZJ18B T-77 MTZJ3.9B T-77 MTZJ33B T-77 MTZJ5.1B T-77 MTZJ5.6B T-77 MTZJ6.8B MTZJ6.8B T-77 MTZJ9.1B T-77	10ELS6N-TA1B2 11E1-EIC 11ES1-EIC SB340L-6737	21DQ09N-TA2B1 RM11C-EIC RMPG06J-G3 RU2AM-EIC SB290S	1SS226(TE85L) KDS120RTK KDS121RTK	MCL4148	SLR-342VCT32

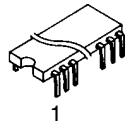
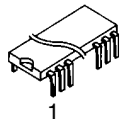
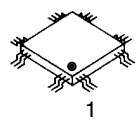
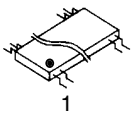
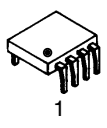
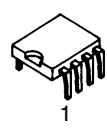
### IC

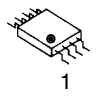
					
OEC6070B TB1253N	MM1311AD	LA9702WL LC78661W ZR36705 ZR36732	AN5829S BU4066BCF CD4053BNSR LA6560 M62420FP MSM5416258B-30 MSM56V16160F-8 PCM1748E SN74LV4052APW SST39VF800A-70-4	S-24C04BFJ-TB	S-24C08ADPA-01

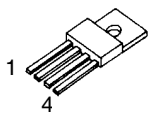
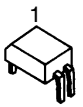
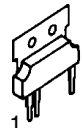
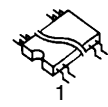
					
LA7151M-TLM NJM4580M	PST3245NR	KIA78R05PI KIA78R09API	LTV-817M-VB	AN7522	TC90A45F

### TRANSISTOR

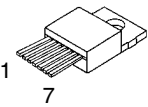
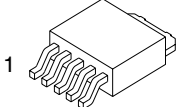
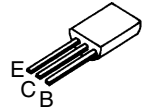
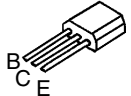
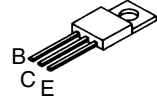
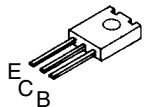
					
LA78040	PQ070XZ01ZP	2SA1624-AA 2SB1131(S,T)-AE KTA1266-AT(Y,GR)	2SC1740SP TP KRC114MAT KTC3198-AT(Y,GR) KTC3203_Y-AT KTC3209_Y-AT KTC3227_Y-AT	2SK3326(2)	2SB1143(S,T,U)

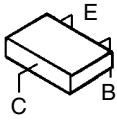

2SA1036KT146  
 2SK3018  
 KRA101SRTK  
 KRA102SRTK  
 KRC102SRTK  
 KRC103SRTK  
 KRC104SRTK  
 KRC111SRTK  
 KTA1504S\_Y\_RTK  
 KTC3875S\_Y\_RTK  
 KTC3881S-RTK

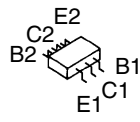

HN1C03F\_B(TE85L) 2SD2499

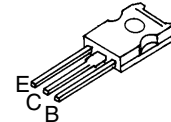
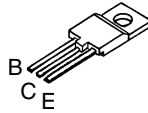

KTC4217(O,Y)



**BLOCK DIAGRAMS**

**DVD FRONT/BACK END BLOCK DIAGRAM**

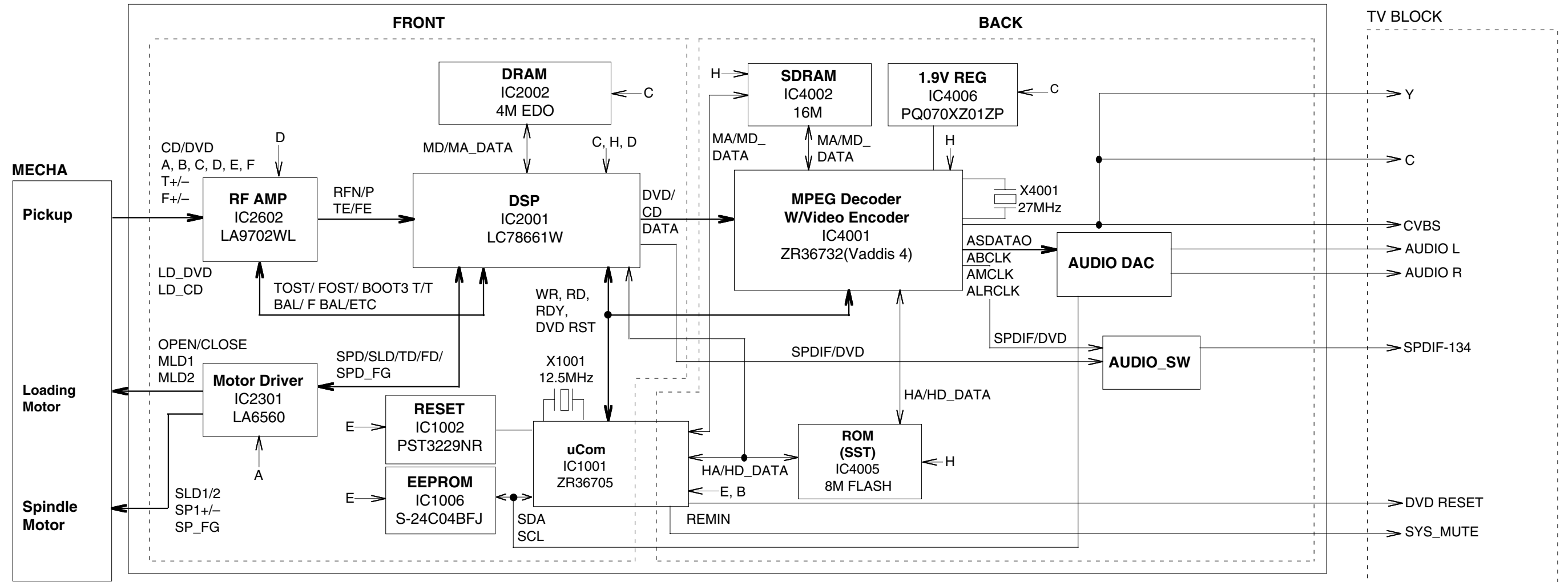

- A P.CON+9V
- B AT+D5V
- C P.CON+D5V
- D P.CON+A5V
- E AT+D3.3V\_M
- F AT+3.3V
- G -20V
- H P.CON+D3.3VA (AT)

TV BLOCK DIAGRAM

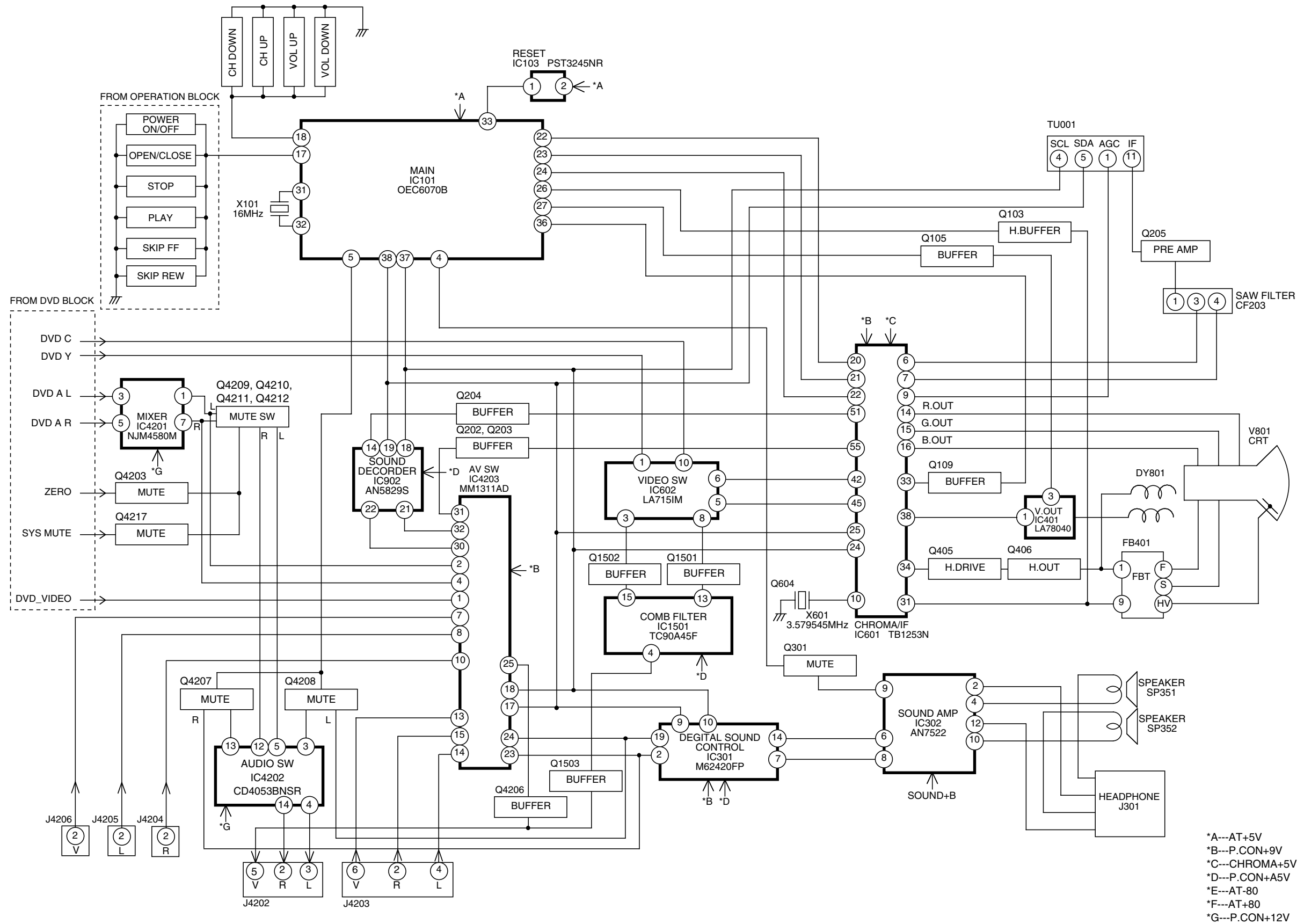

# POWER BLOCK DIAGRAM

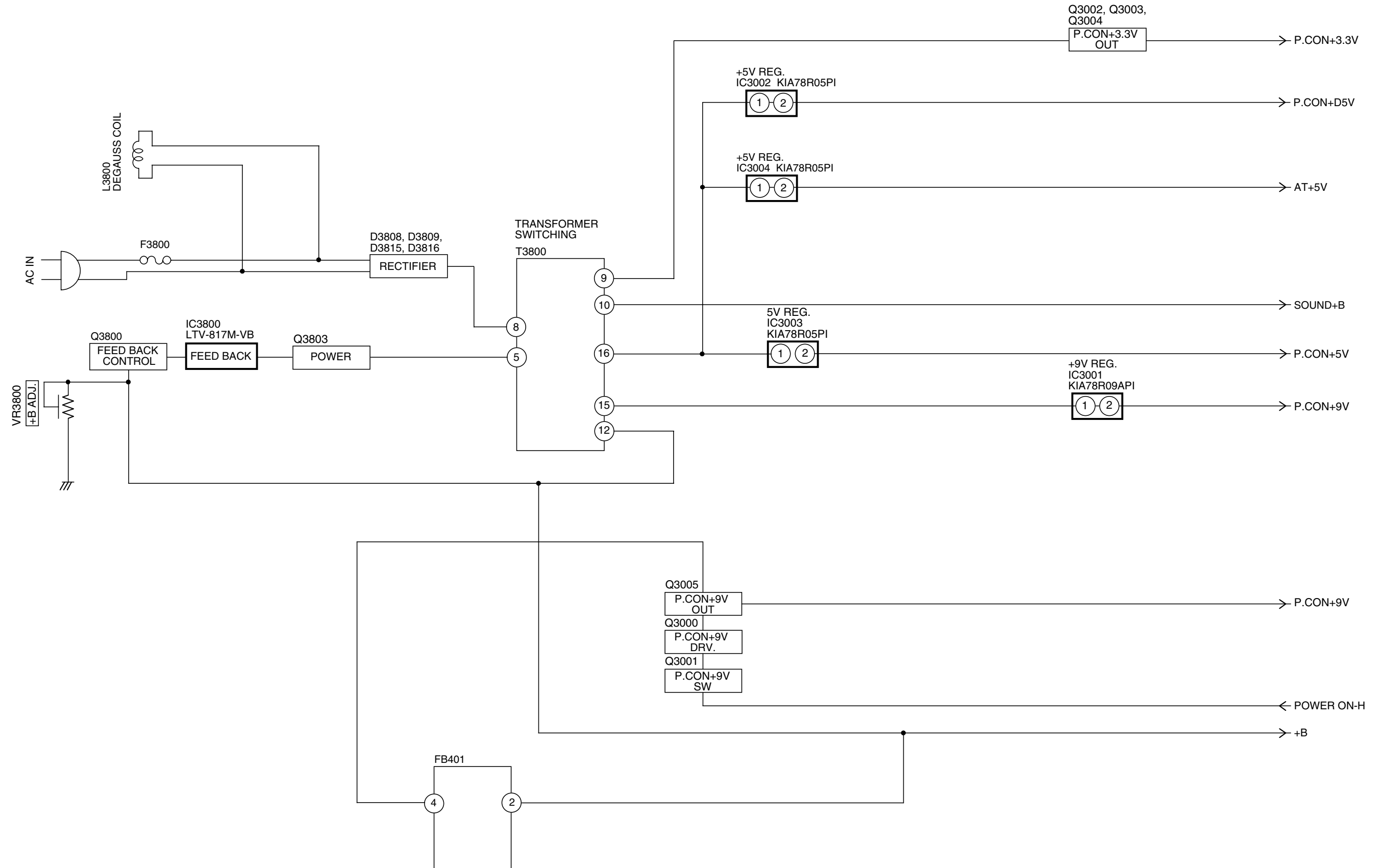



# WIRING CONNECTION DIAGRAM

## INTERCONNECTION DIAGRAM

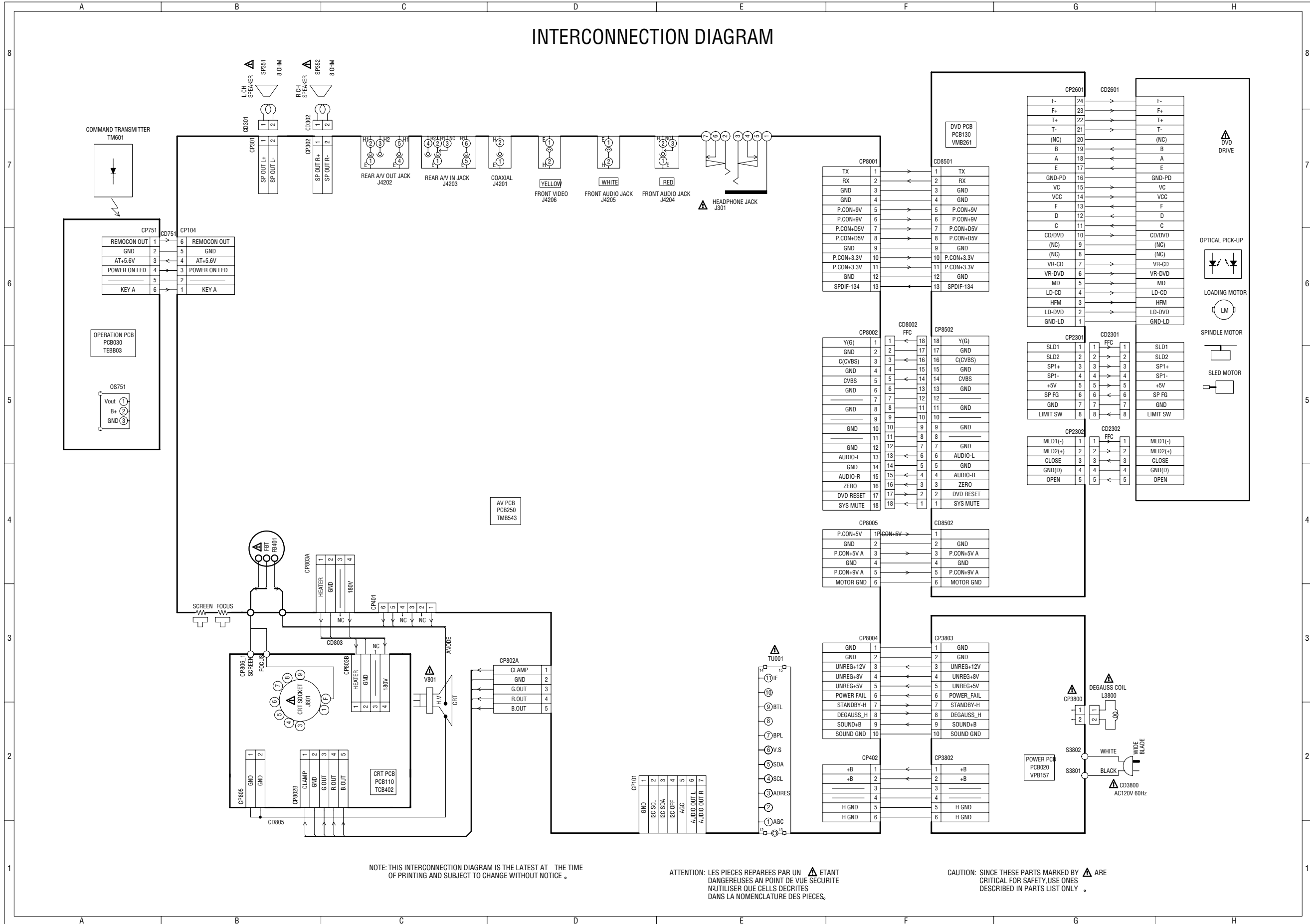

# SCHEMATIC DIAGRAM

[DVD PCB MPEG SCHEMATIC DIAGRAM]

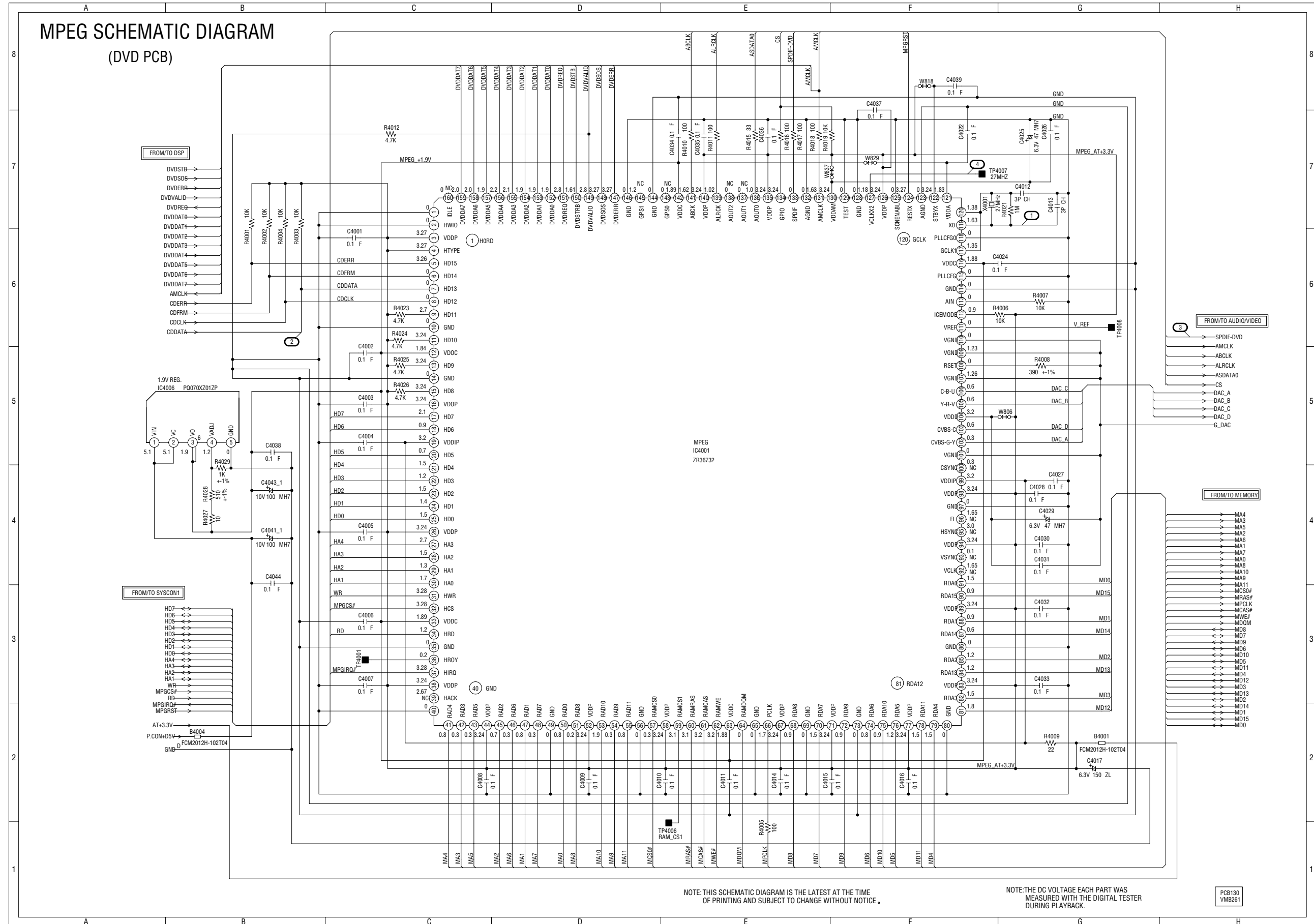

NOTE: THIS SCHEMATIC DIAGRAM IS THE LATEST AT THE TIME OF PRINTING AND SUBJECT TO CHANGE WITHOUT NOTICE .

NOTE: THE DC VOLTAGE EACH PART WAS MEASURED WITH THE DIGITAL TESTER DURING PLAYBACK.

PCB130  
VMB261

[DVD PCB MEMORY SCHEMATIC DIAGRAM]

MEMORY SCHEMATIC DIAGRAM  
(DVD PCB)

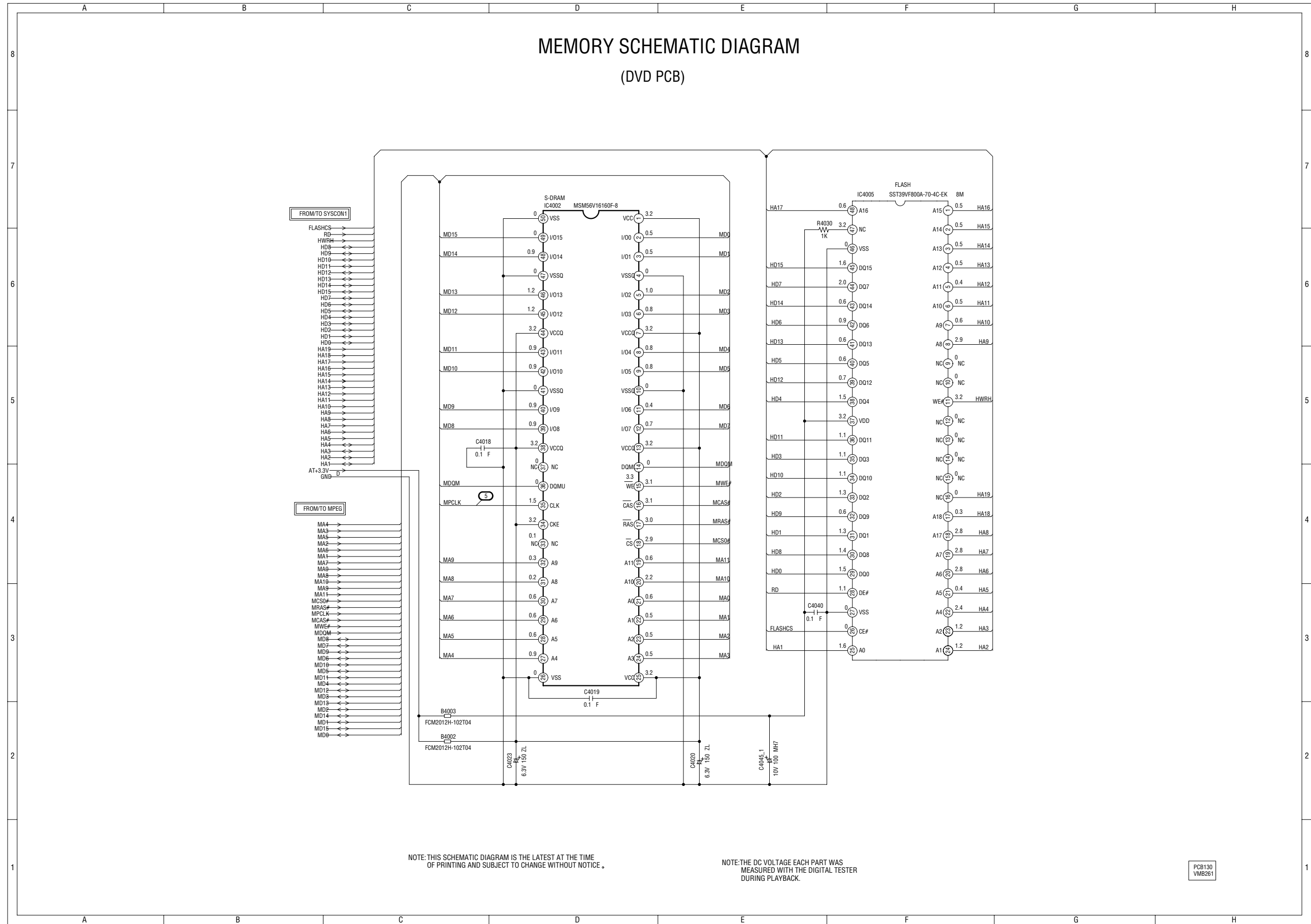

NOTE: THIS SCHEMATIC DIAGRAM IS THE LATEST AT THE TIME OF PRINTING AND SUBJECT TO CHANGE WITHOUT NOTICE.

NOTE: THE DC VOLTAGE EACH PART WAS MEASURED WITH THE DIGITAL TESTER DURING PLAYBACK.

PCB130  
VMB261

[DVD PCB SYSCON1 SCHEMATIC DIAGRAM]

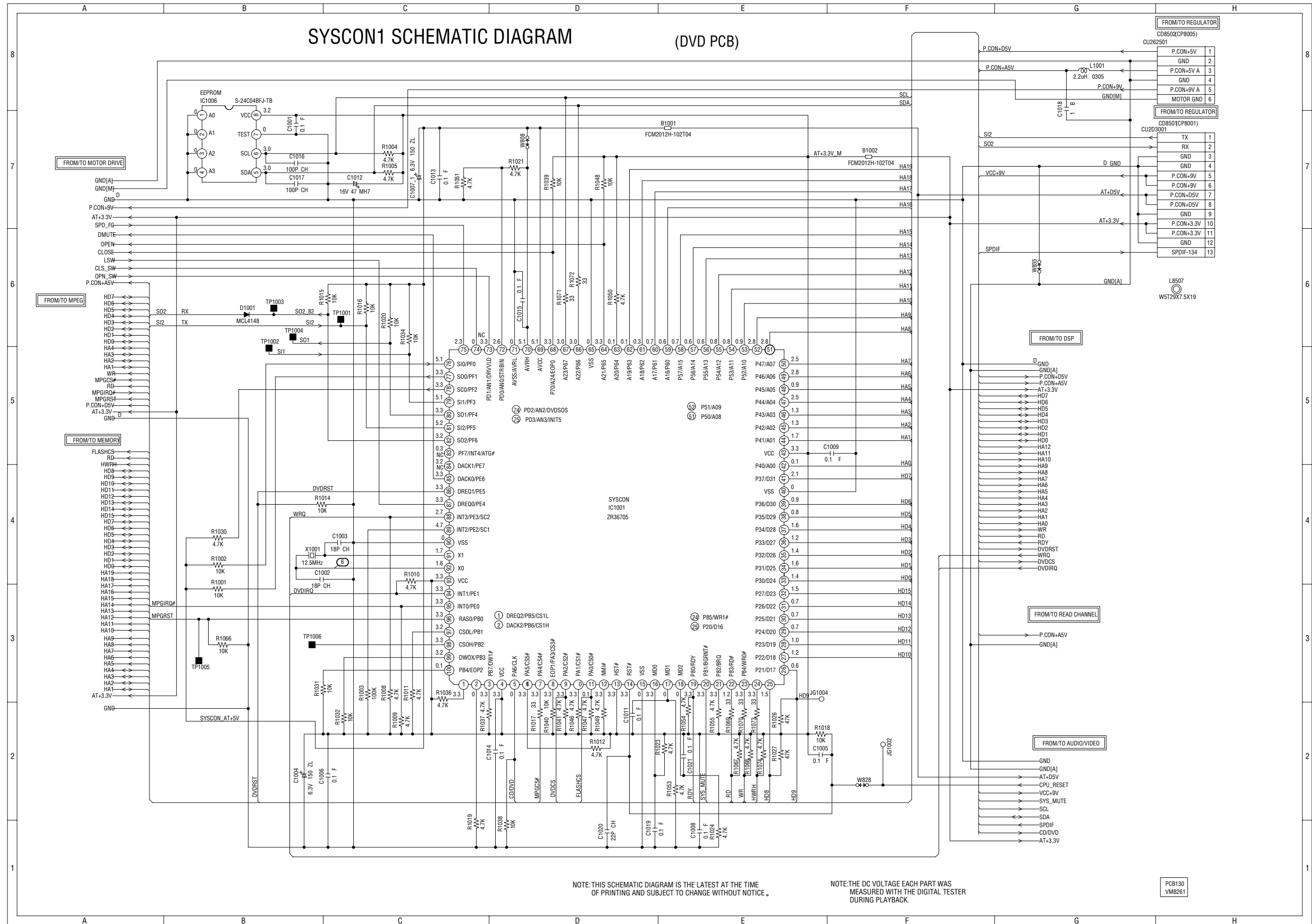

[DVD PCB DSP SCHEMATIC DIAGRAM]

DSP SCHEMATIC DIAGRAM

(DVD PCB)

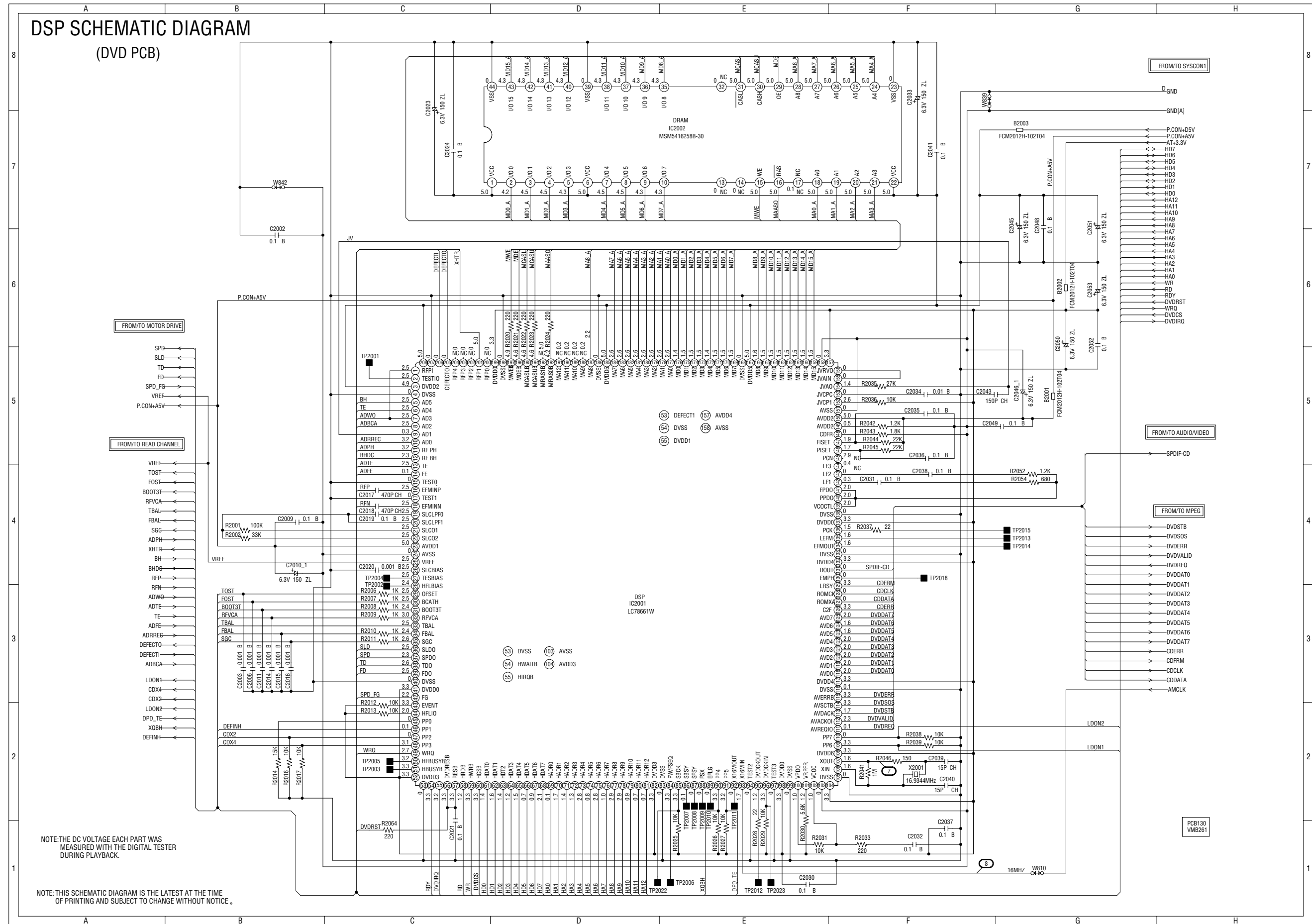

[DVD PCB MOTOR DRIVE SCHEMATIC DIAGRAM]

MOTOR DRIVE SCHEMATIC DIAGRAM  
(DVD PCB)

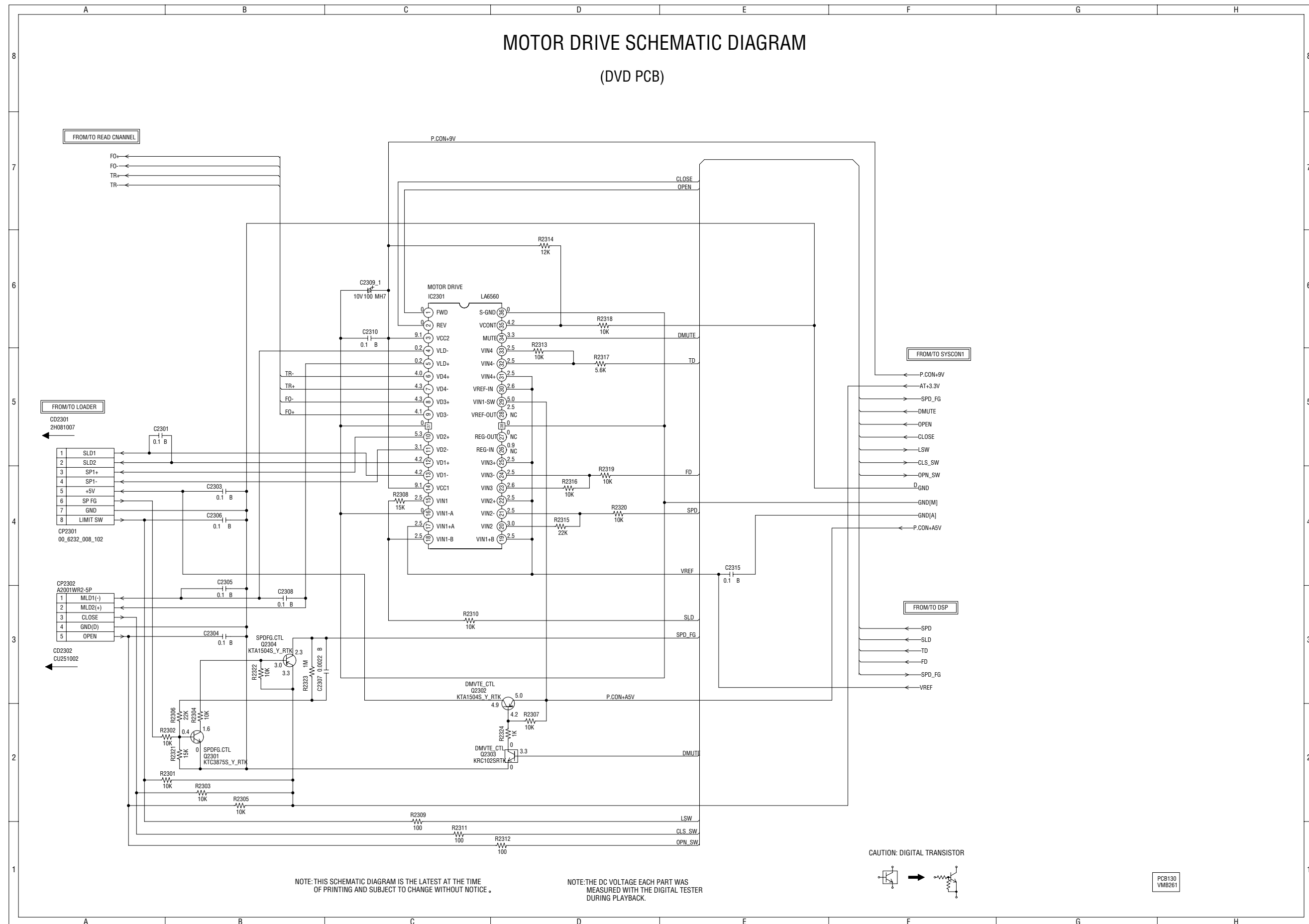

[DVD PCB READ CHANNEL SCHEMATIC DIAGRAM]

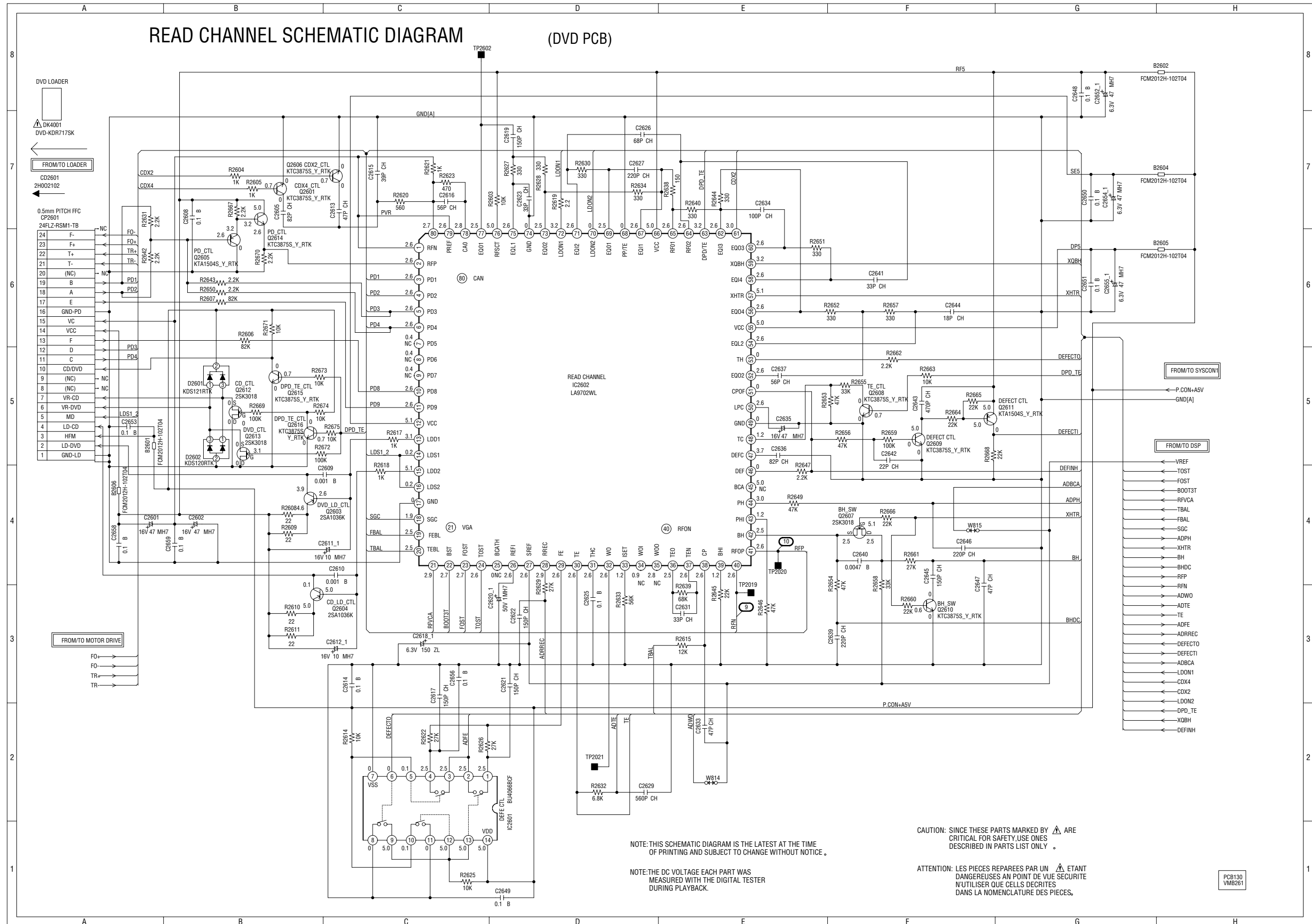

NOTE: THIS SCHEMATIC DIAGRAM IS THE LATEST AT THE TIME OF PRINTING AND SUBJECT TO CHANGE WITHOUT NOTICE.

NOTE: THE DC VOLTAGE EACH PART WAS MEASURED WITH THE DIGITAL TESTER DURING PLAYBACK.

CAUTION: SINCE THESE PARTS MARKED BY  $\triangle$  ARE CRITICAL FOR SAFETY USE ONES DESCRIBED IN PARTS LIST ONLY.

ATTENTION: LES PIÉCES REPARÉES PAR UN  $\triangle$  ÉTANT DANGEREUSES AU POINT DE VUE SÉCURITÉ N'UTILISER QUE CELLES DÉCRITES DANS LA NOMENCLATURE DES PIÉCES.

PC8130 VMB261

[DVD PCB AUDIO/VIDEO SCHEMATIC DIAGRAM]

AUDIO/VIDEO SCHEMATIC DIAGRAM  
(DVD PCB)

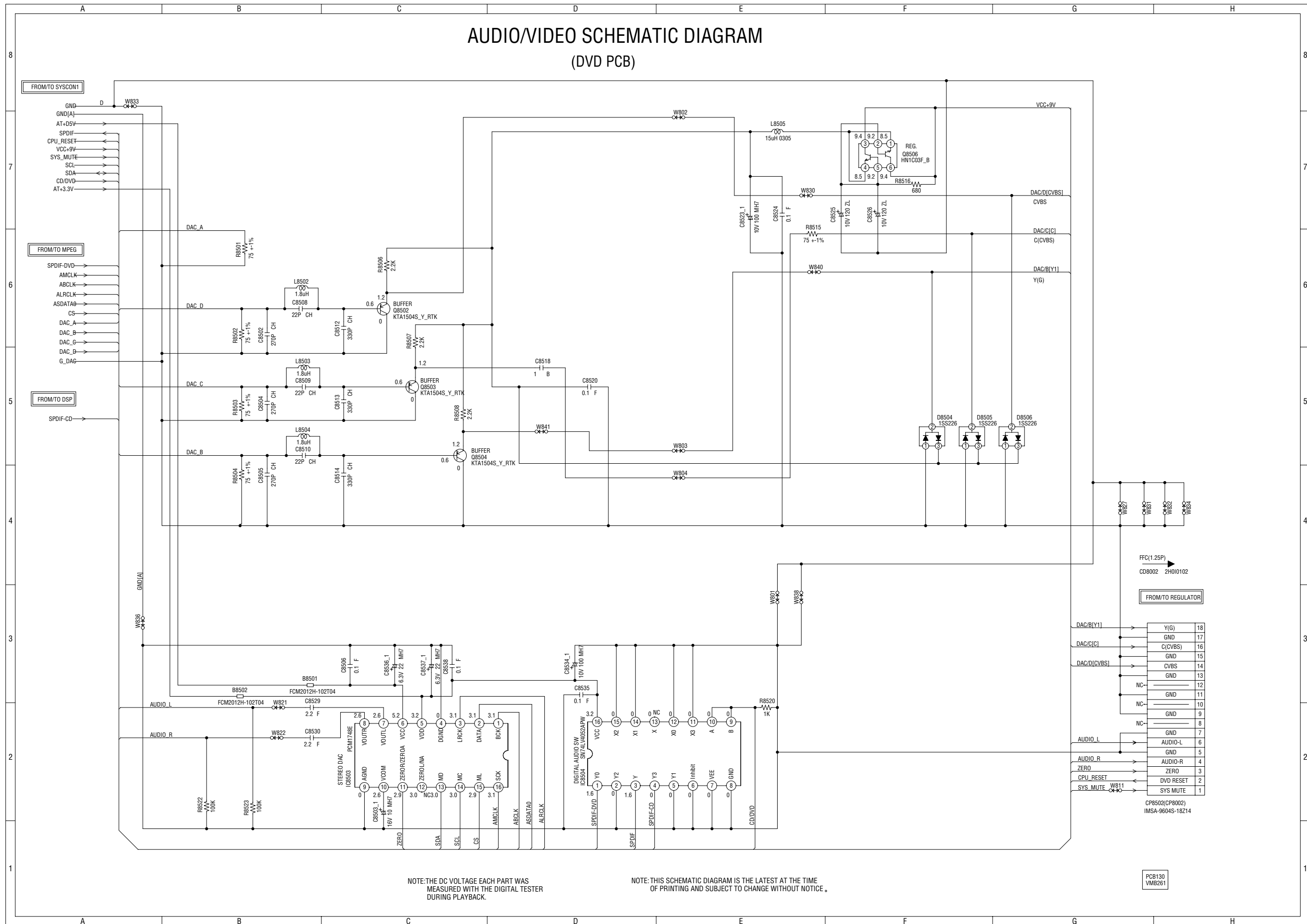

NOTE:THE DC VOLTAGE EACH PART WAS MEASURED WITH THE DIGITAL TESTER DURING PLAYBACK.

NOTE:THIS SCHEMATIC DIAGRAM IS THE LATEST AT THE TIME OF PRINTING AND SUBJECT TO CHANGE WITHOUT NOTICE.

PCB130  
VM8261



[AV PCB REGULATOR SCHEMATIC DIAGRAM]

REGULATOR SCHEMATIC DIAGRAM (AV PCB)

NOTE: THE DC VOLTAGE EACH PART WAS MEASURED WITH THE DIGITAL TESTER DURING PLAYBACK.

NOTE: THIS SCHEMATIC DIAGRAM IS THE LATEST AT THE TIME OF PRINTING AND SUBJECT TO CHANGE WITHOUT NOTICE.

CAUTION: SINCE THESE PARTS MARKED BY Δ ARE CRITICAL FOR SAFETY, USE ONES DESCRIBED IN PARTS LIST ONLY.

ATTENTION: LES PIÈCES RÉPARÉES PAR UN Δ ÉTANT DANGEREUSES AN POINT DE VUE SECURITE N'UTILISER QUE CELLES DÉCRITES DANS LA NOMENCLATURE DES PIÈCES.

- ◀ DIGITAL AUDIO SIGNAL (PB)
- ▶ PLAYBACK LUMINANCE SIGNAL
- ◀▶ PLAYBACK COLOR SIGNAL
- ◀▶▶ PLAYBACK VIDEO SIGNAL
- ◀▶▶▶ AUDIO SIGNAL (PB)

CAUTION: DIGITAL TRANSISTOR

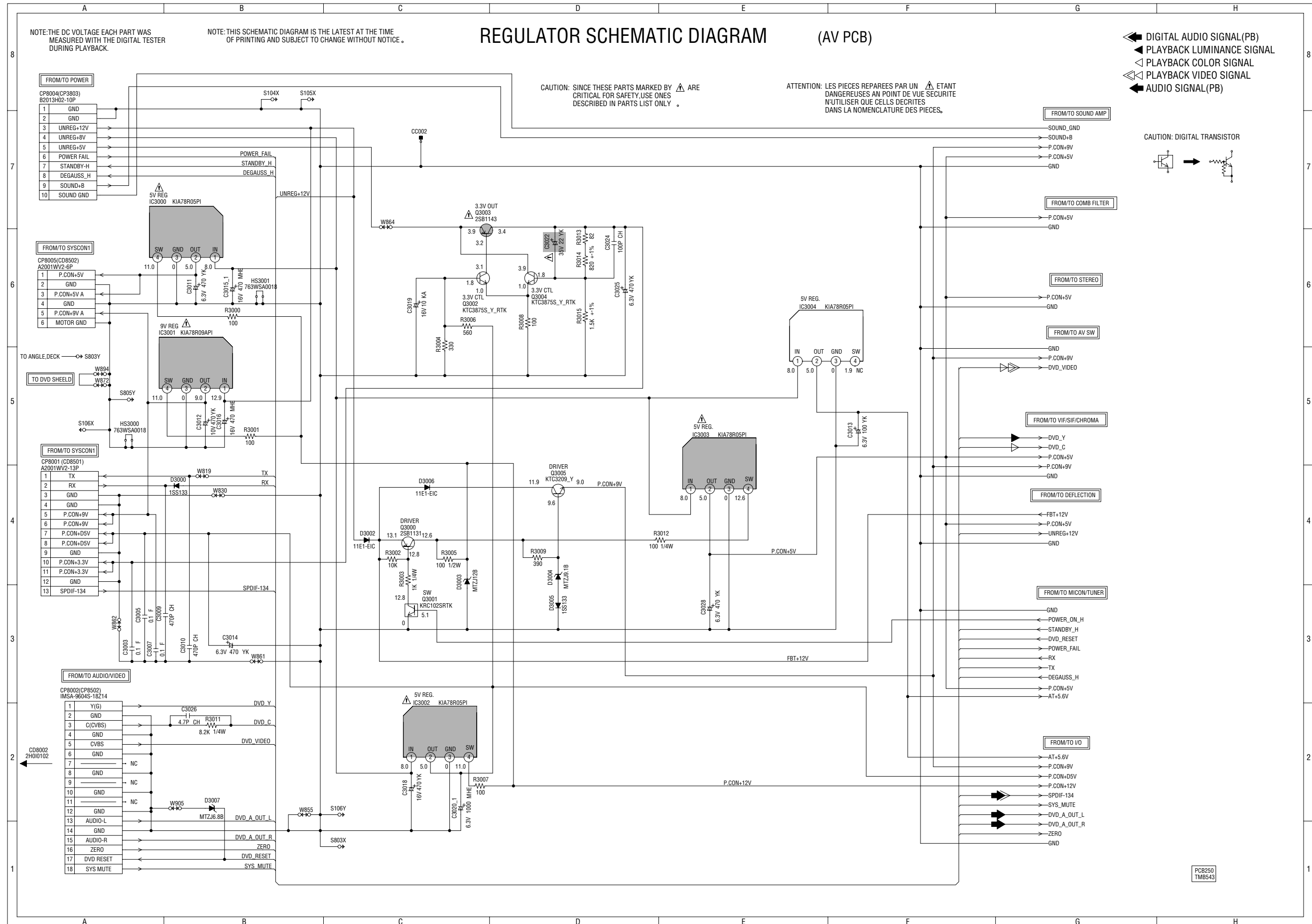

PCB250 TM8543

[AV PCB MICON/TUNER SCHEMATIC DIAGRAM]

MICON /TUNER SCHEMATIC DIAGRAM (AV PCB)

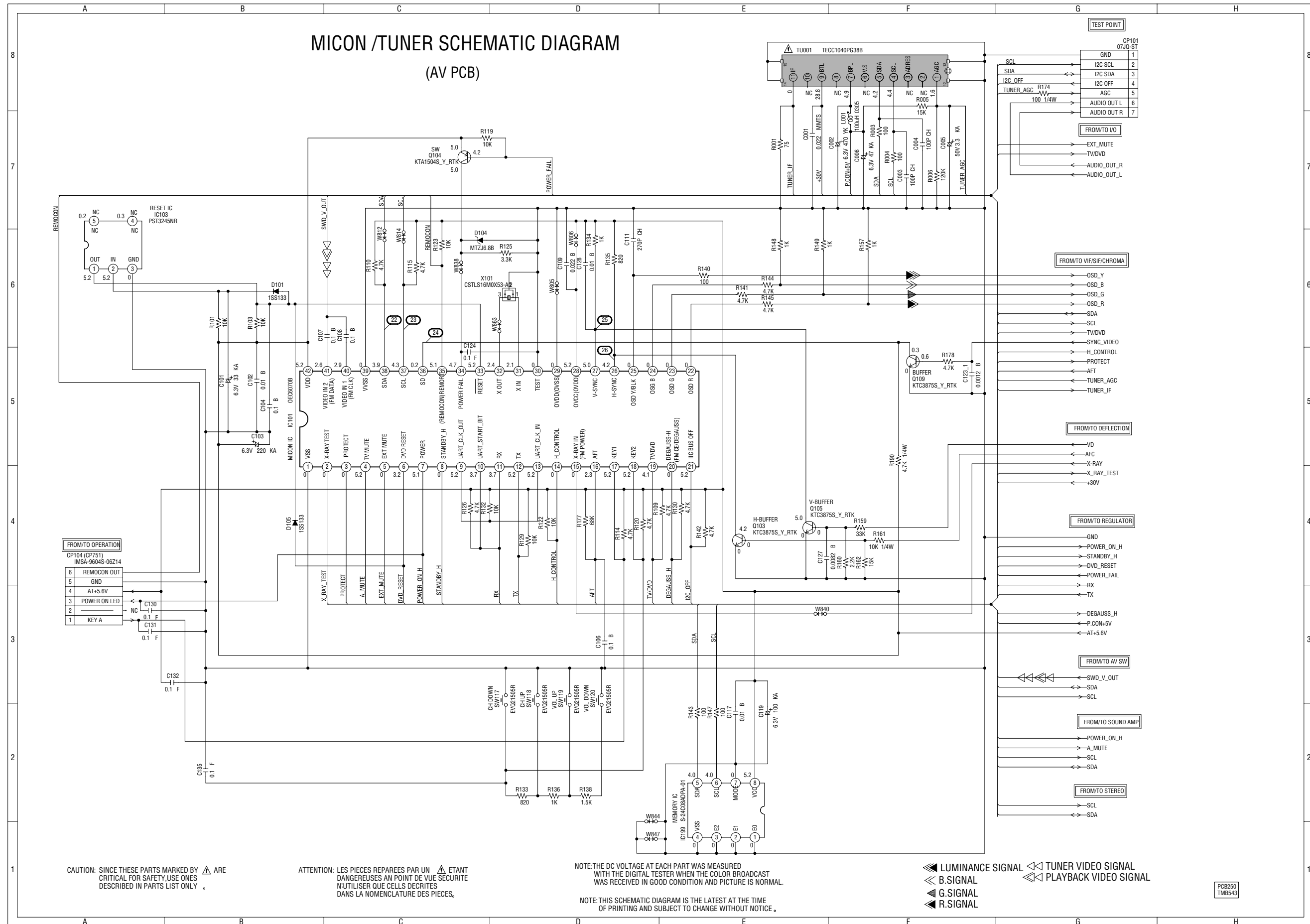

[AV PCB VIF/ SIF/ CHROMA SCHEMATIC DIAGRAM]

VIF/SIF/CHROMA SCHEMATIC DIAGRAM (AV PCB)

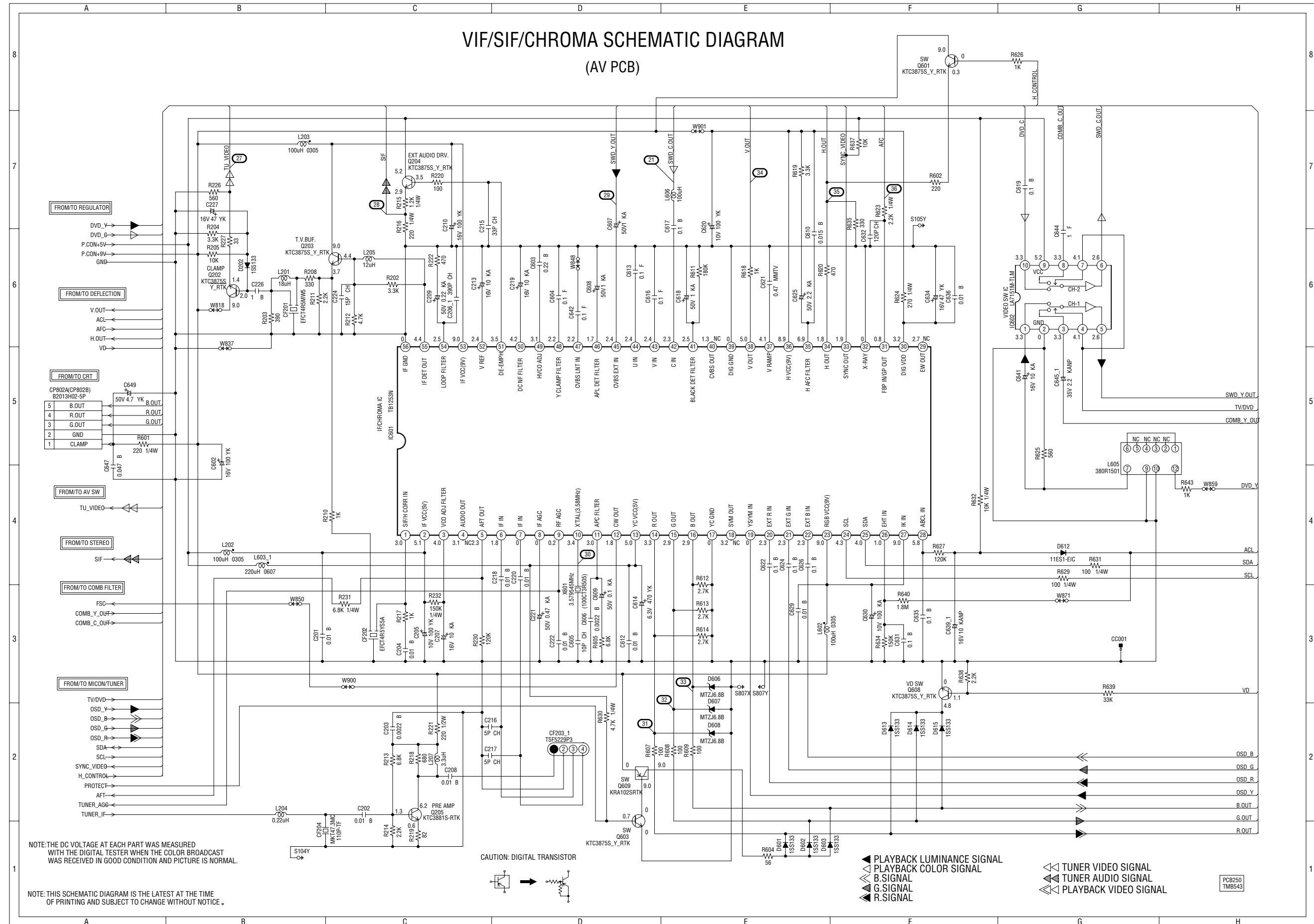

PCB250 TMB543

[AV PCB SOUND AMP SCHEMATIC DIAGRAM]

SOUND AMP SCHEMATIC DIAGRAM

(AV PCB)

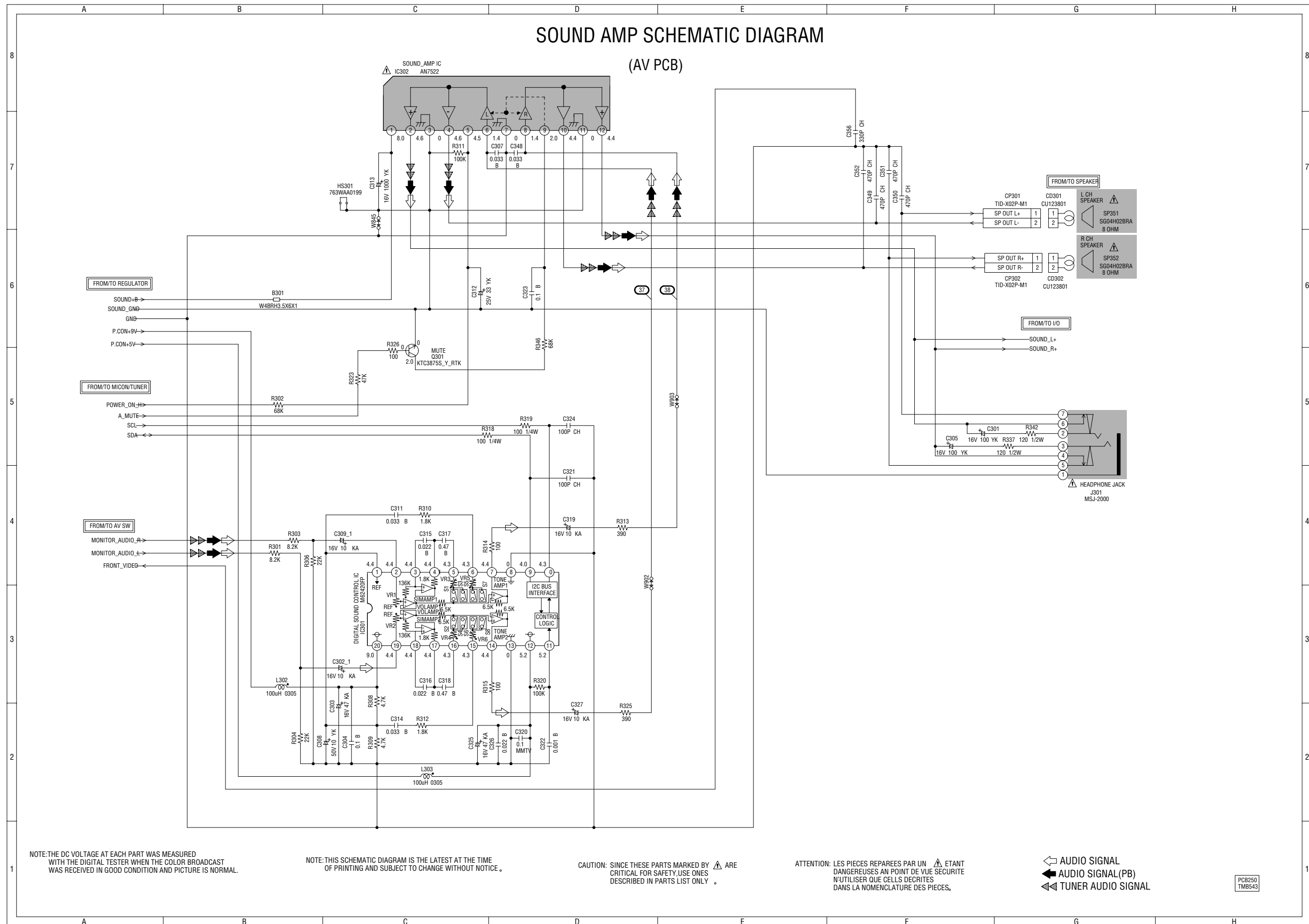

NOTE: THE DC VOLTAGE AT EACH PART WAS MEASURED WITH THE DIGITAL TESTER WHEN THE COLOR BROADCAST WAS RECEIVED IN GOOD CONDITION AND PICTURE IS NORMAL.

NOTE: THIS SCHEMATIC DIAGRAM IS THE LATEST AT THE TIME OF PRINTING AND SUBJECT TO CHANGE WITHOUT NOTICE.

CAUTION: SINCE THESE PARTS MARKED BY ARE CRITICAL FOR SAFETY, USE ONES DESCRIBED IN PARTS LIST ONLY.

ATTENTION: LES PIÈCES REPARÉES PAR UN ÉTANT DANGEREUSES AU POINT DE VUE SÉCURITÉ, N'UTILISER QUE CELLES DÉCRITES DANS LA NOMENCLATURE DES PIÈCES.

AUDIO SIGNAL  
 AUDIO SIGNAL (PB)  
 TUNER AUDIO SIGNAL

PCB250  
TMB543

[AV PCB I/O SCHEMATIC DIAGRAM]

### I/O SCHEMATIC DIAGRAM (AV PCB)

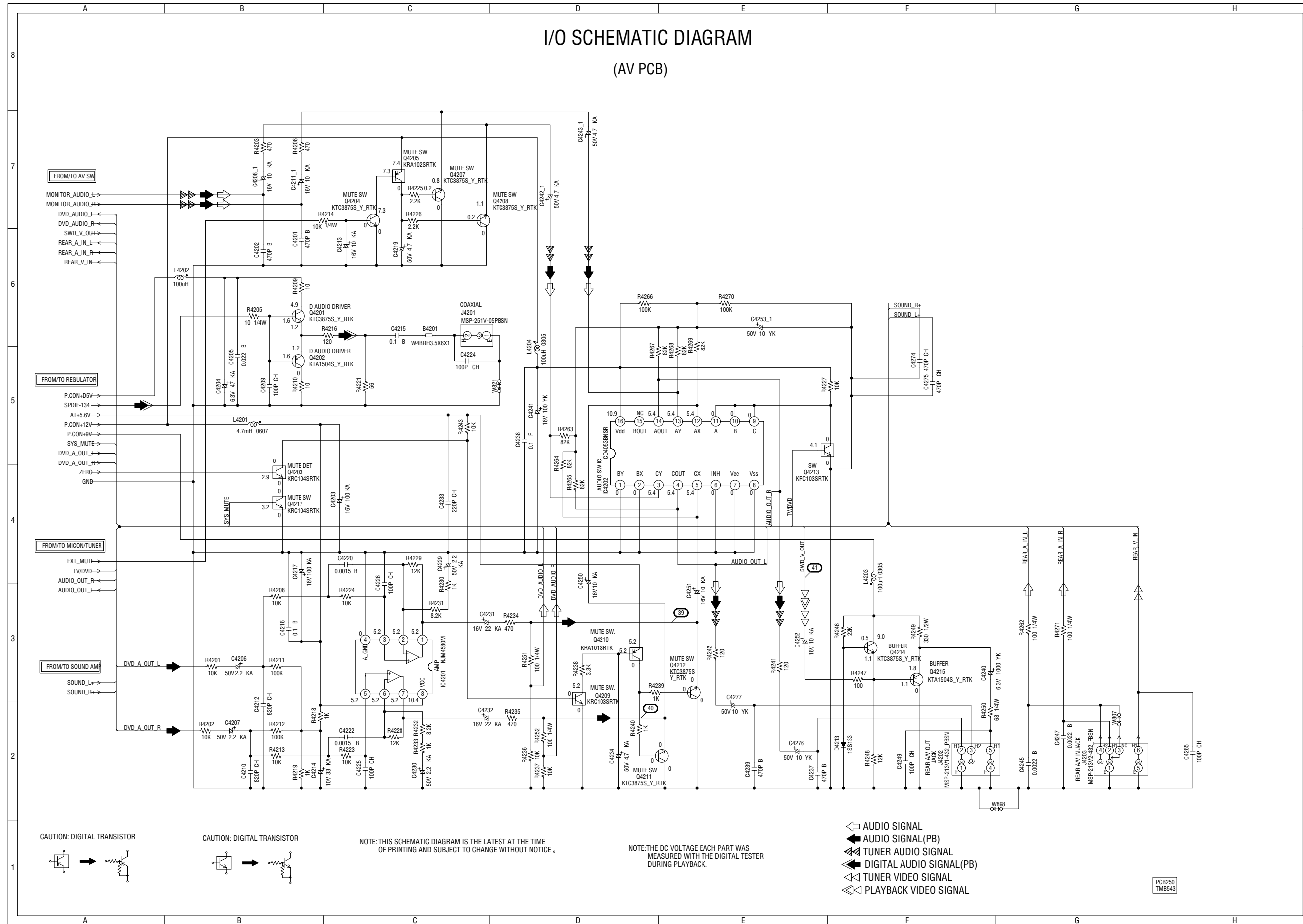

[AV PCB AV SW SCHEMATIC DIAGRAM]

# AV SW SCHEMATIC DIAGRAM (AV PCB)

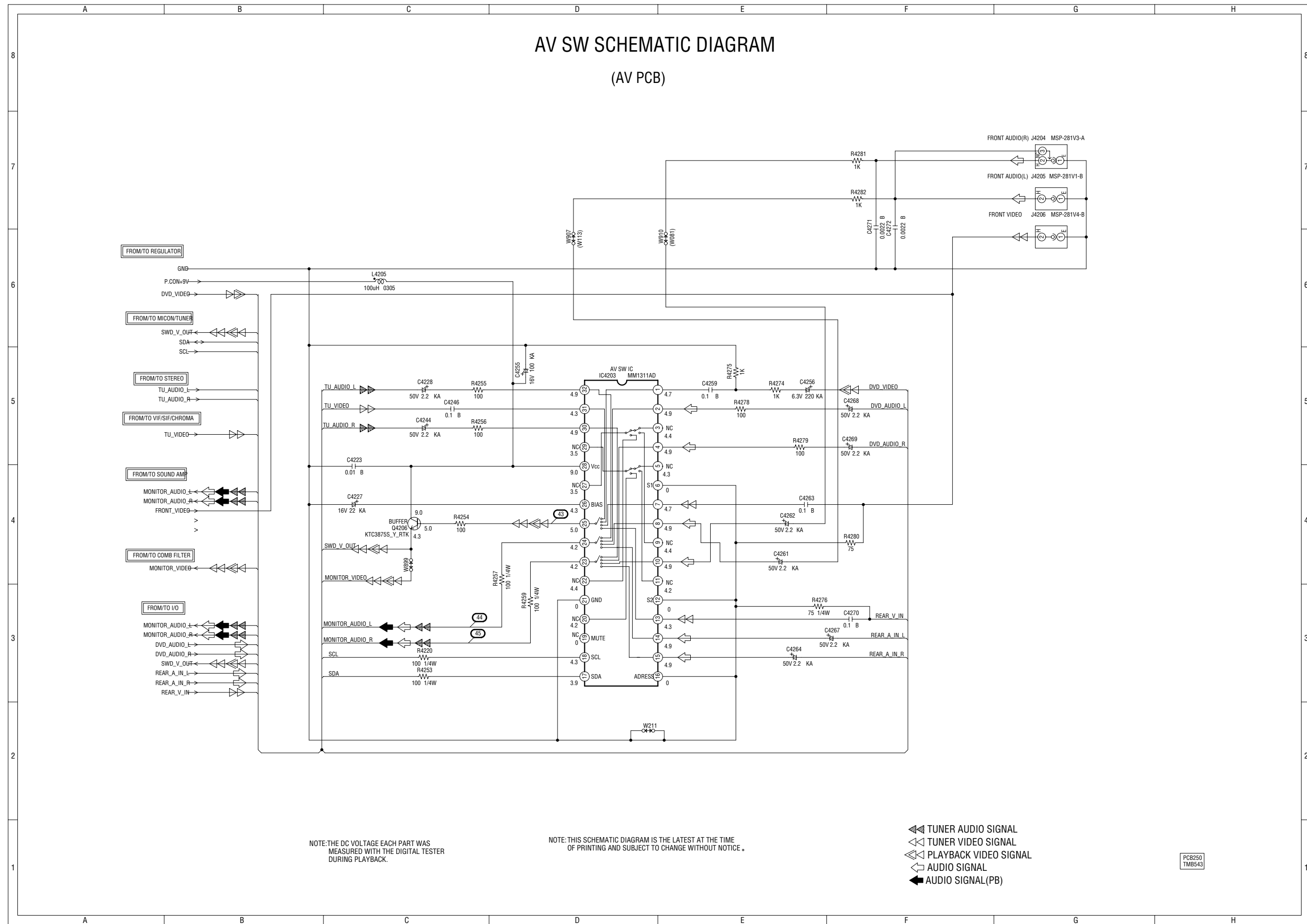

NOTE: THE DC VOLTAGE EACH PART WAS MEASURED WITH THE DIGITAL TESTER DURING PLAYBACK.

NOTE: THIS SCHEMATIC DIAGRAM IS THE LATEST AT THE TIME OF PRINTING AND SUBJECT TO CHANGE WITHOUT NOTICE.

- ▶▶▶ TUNER AUDIO SIGNAL
- ▶▶▶ TUNER VIDEO SIGNAL
- ▶▶▶ PLAYBACK VIDEO SIGNAL
- ▶▶▶ AUDIO SIGNAL
- ▶▶▶ AUDIO SIGNAL (PB)

PCB250  
TMB543

[AV PCB COMB FILTER SCHEMATIC DIAGRAM]

# COMB FILTER SCHEMATIC DIAGRAM

(AV PCB)

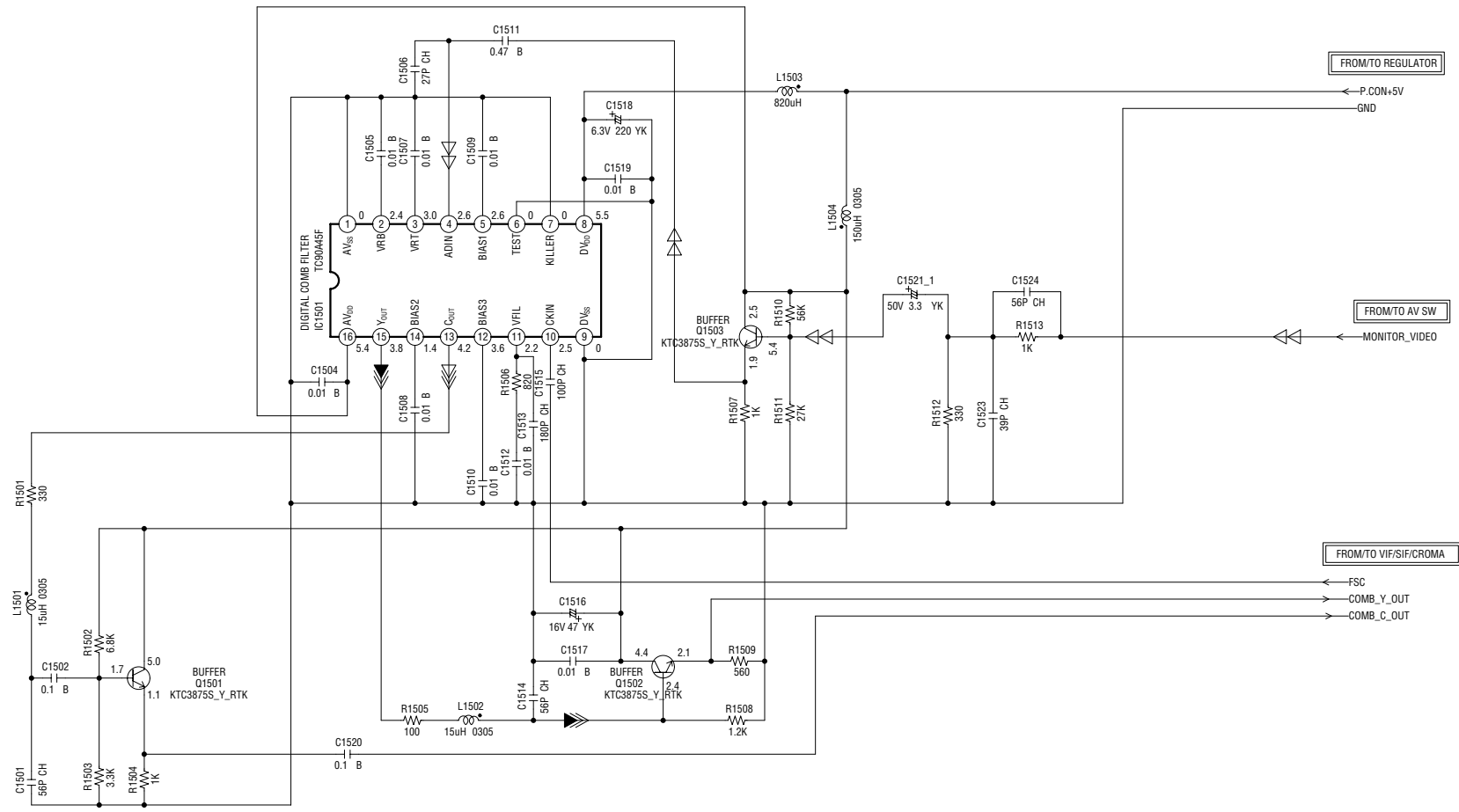

NOTE: THIS SCHEMATIC DIAGRAM IS THE LATEST AT THE TIME OF PRINTING AND SUBJECT TO CHANGE WITHOUT NOTICE.

NOTE: THE DC VOLTAGE AT EACH PART WAS MEASURED WITH THE DIGITAL TESTER WHEN THE COLOR BROADCAST WAS RECEIVED IN GOOD CONDITION AND PICTURE IS NORMAL.

- ◀ RECORD COLOR SIGNAL
- ◀ RECORD LUMINANCE SIGNAL
- ◀ TUNER VIDEO SIGNAL
- ◀ PLAYBACK VIDEO SIGNAL

PCB250  
TMB543

[AV PCB STROBE SCHEMATIC DIAGRAM]

# STEREO SCHEMATIC DIAGRAM

(AV PCB)

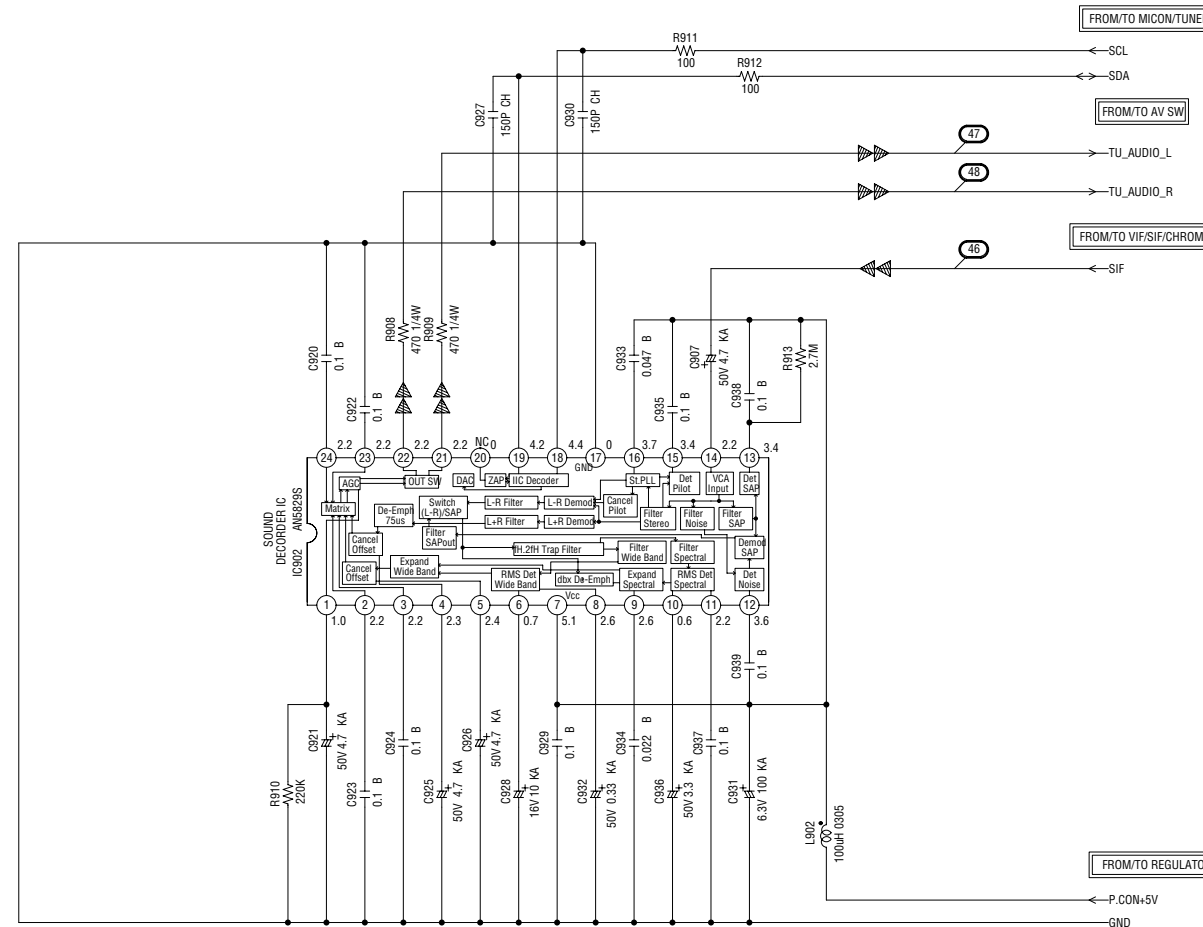

NOTE: THE DC VOLTAGE AT EACH PART WAS MEASURED WITH THE DIGITAL TESTER WHEN THE COLOR BROADCAST WAS RECEIVED IN GOOD CONDITION AND PICTURE IS NORMAL.

NOTE: THIS SCHEMATIC DIAGRAM IS THE LATEST AT THE TIME OF PRINTING AND SUBJECT TO CHANGE WITHOUT NOTICE.

TUNER AUDIO SIGNAL

PCB250  
TMB543



[AV PCB DEFLECTION SCHEMATIC DIAGRAM]

DEFLECTION SCHEMATIC DIAGRAM  
(AV PCB)

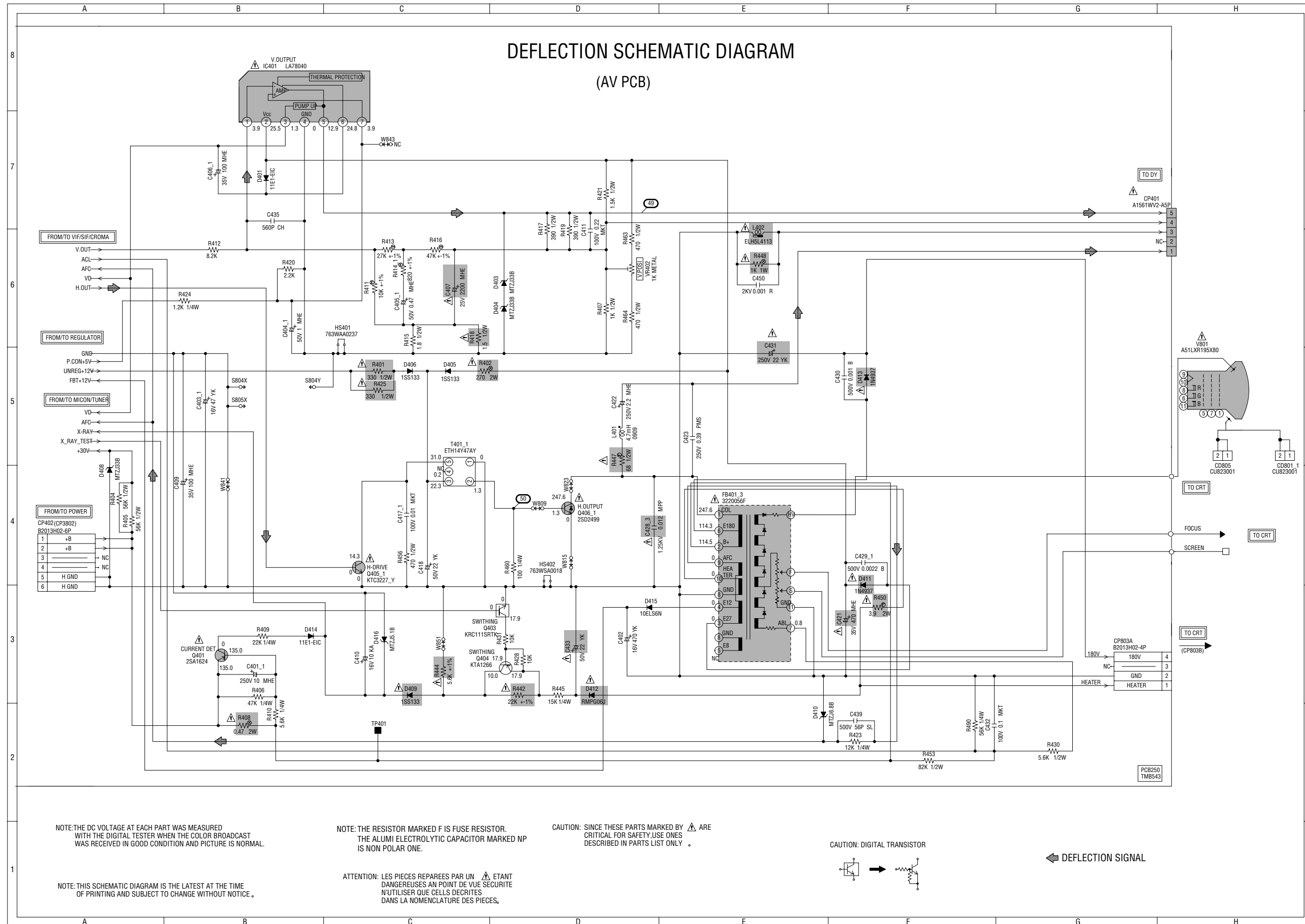

NOTE: THE DC VOLTAGE AT EACH PART WAS MEASURED WITH THE DIGITAL TESTER WHEN THE COLOR BROADCAST WAS RECEIVED IN GOOD CONDITION AND PICTURE IS NORMAL.

NOTE: THE RESISTOR MARKED F IS FUSE RESISTOR. THE ALUMI ELECTROLYTIC CAPACITOR MARKED NP IS NON POLAR ONE.

CAUTION: SINCE THESE PARTS MARKED WITH A TRIANGLE ARE CRITICAL FOR SAFETY, USE ONES DESCRIBED IN PARTS LIST ONLY.

CAUTION: DIGITAL TRANSISTOR

DEFLECTION SIGNAL

NOTE: THIS SCHEMATIC DIAGRAM IS THE LATEST AT THE TIME OF PRINTING AND SUBJECT TO CHANGE WITHOUT NOTICE.

ATTENTION: LES PIÈCES REPARÉES PAR UN TRIANGLE ÉTANT DANGEREUSES AN POINT DE VUE SECURITE N'UTILISER QUE CELLS DÉCRITES DANS LA NOMENCLATURE DES PIÈCES.

[CRT PCB SCHEMATIC DIAGRAM]

CRT SCHEMATIC DIAGRAM  
(CRT PCB)

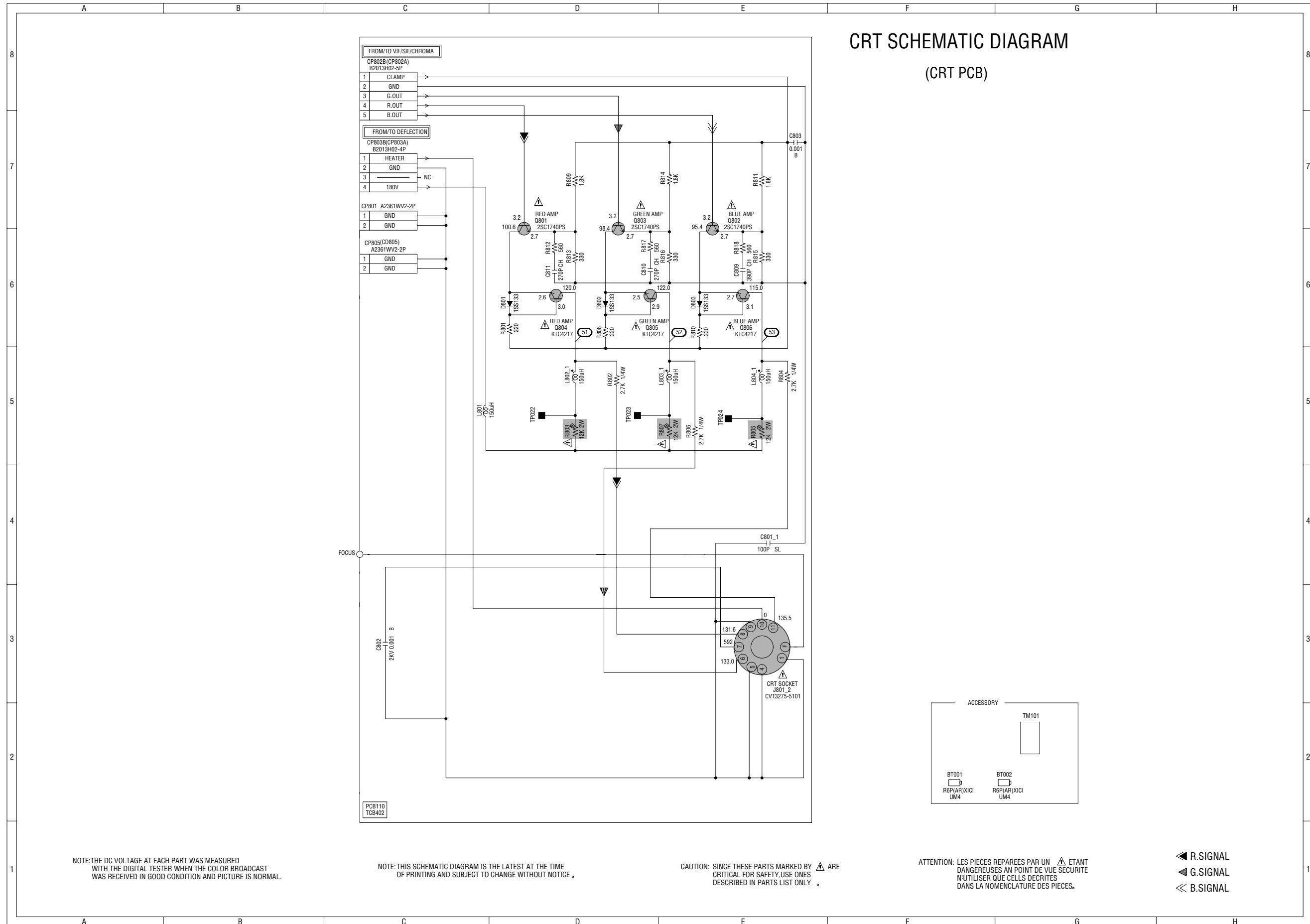

NOTE:THE DC VOLTAGE AT EACH PART WAS MEASURED WITH THE DIGITAL TESTER WHEN THE COLOR BROADCAST WAS RECEIVED IN GOOD CONDITION AND PICTURE IS NORMAL.

NOTE:THIS SCHEMATIC DIAGRAM IS THE LATEST AT THE TIME OF PRINTING AND SUBJECT TO CHANGE WITHOUT NOTICE .

CAUTION: SINCE THESE PARTS MARKED BY ARE CRITICAL FOR SAFETY,USE ONES DESCRIBED IN PARTS LIST ONLY .

ATTENTION: LES PIECES REPARÉES PAR UN ETANT DANGEREUSES AN POINT DE VUE SECURITE N'UTILISER QUE CELLS DECRITES DANS LA NOMENCLATURE DES PIECES.

◀ R.SIGNAL  
◀ G.SIGNAL  
◀ B.SIGNAL

[POWER PCB SCHEMATIC DIAGRAM]

POWER SCHEMATIC DIAGRAM (POWER PCB)

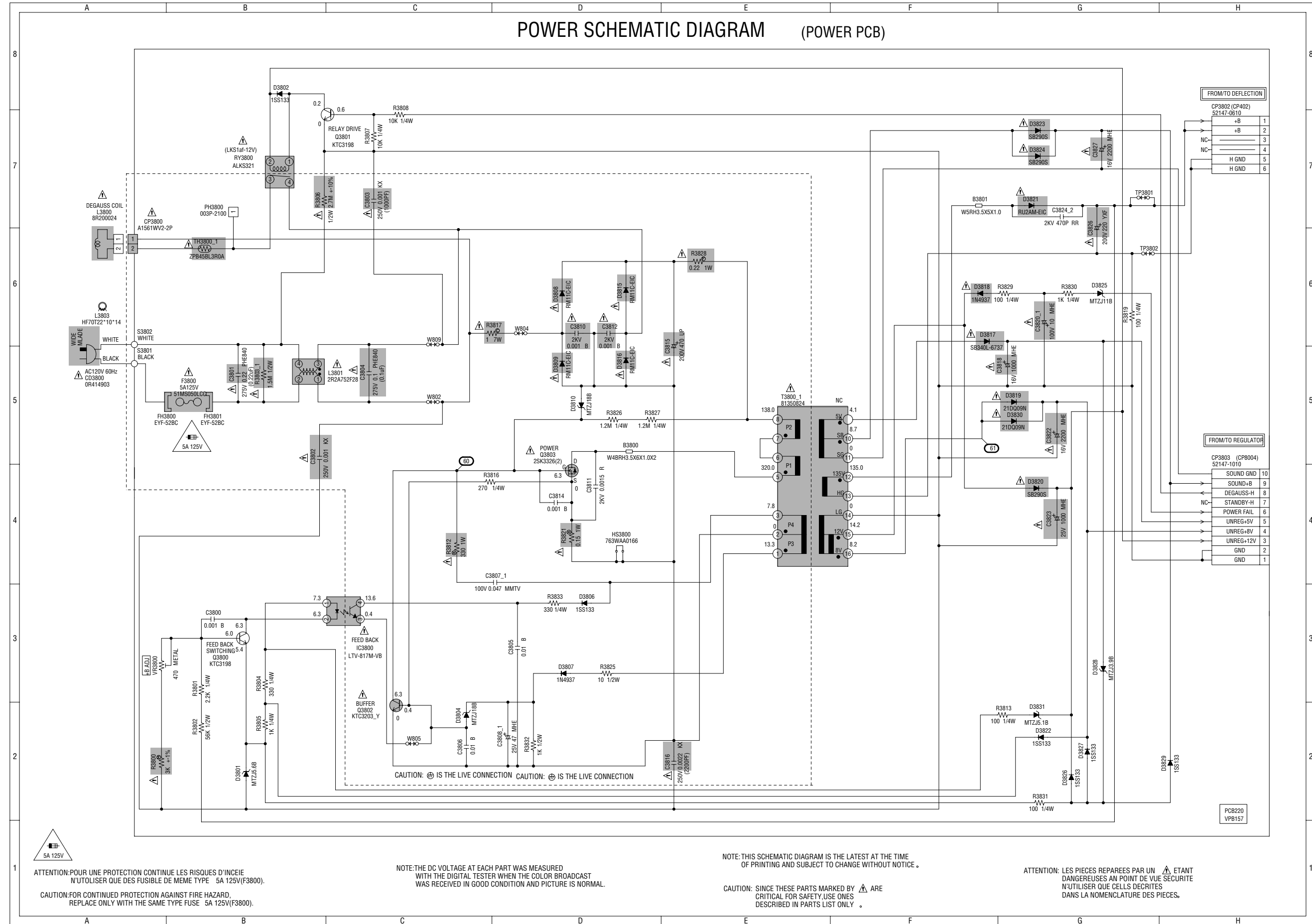

ATTENTION: POUR UNE PROTECTION CONTINUE LES RISQUES D'INCENDIE N'UTILISER QUE DES FUSIBLE DE MEME TYPE 5A 125V(F3800).  
 CAUTION: FOR CONTINUED PROTECTION AGAINST FIRE HAZARD, REPLACE ONLY WITH THE SAME TYPE FUSE 5A 125V(F3800).

NOTE: THE DC VOLTAGE AT EACH PART WAS MEASURED WITH THE DIGITAL TESTER WHEN THE COLOR BROADCAST WAS RECEIVED IN GOOD CONDITION AND PICTURE IS NORMAL.

NOTE: THIS SCHEMATIC DIAGRAM IS THE LATEST AT THE TIME OF PRINTING AND SUBJECT TO CHANGE WITHOUT NOTICE.  
 CAUTION: SINCE THESE PARTS MARKED BY  $\Delta$  ARE CRITICAL FOR SAFETY, USE ONES DESCRIBED IN PARTS LIST ONLY.

ATTENTION: LES PIECES REPAREES PAR UN  $\Delta$  ETANT DANGEREUSES AN POINT DE VUE SECURITE N'UTILISER QUE CELLS DECRITES DANS LA NOMENCLATURE DES PIECES.

[OPERATION PCB SCHEMATIC DIAGRAM]

OPERATION SCHEMATIC DIAGRAM  
(OPERATION PCB)

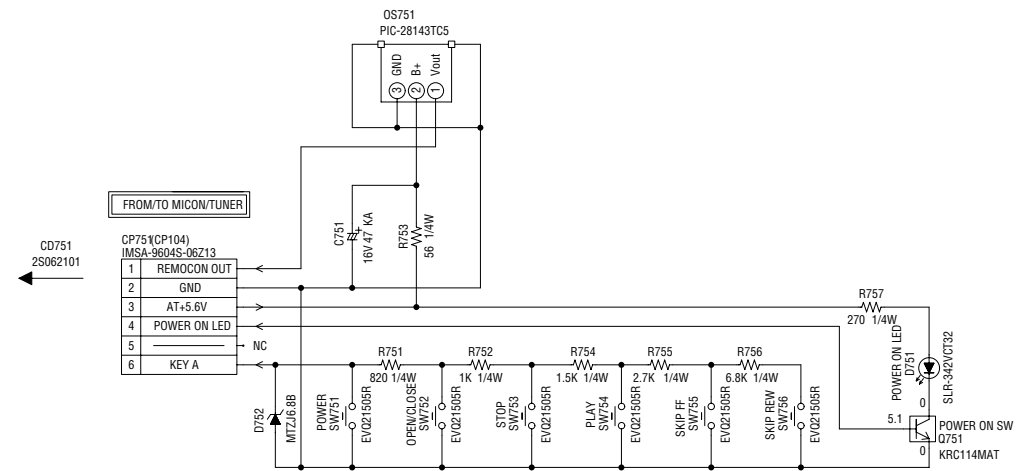

CAUTION: DIGITAL TRANSISTOR

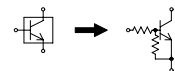

NOTE: THIS SCHEMATIC DIAGRAM IS THE LATEST AT THE TIME OF PRINTING AND SUBJECT TO CHANGE WITHOUT NOTICE.

NOTE: THE DC VOLTAGE AT EACH PART WAS MEASURED WITH THE DIGITAL TESTER WHEN THE COLOR BROADCAST WAS RECEIVED IN GOOD CONDITION AND PICTURE IS NORMAL.

PCB030  
TEB803

**PATTERN DIAGRAMS**  
[DVD PCB PATTERN]

**(TOP SIDE)**

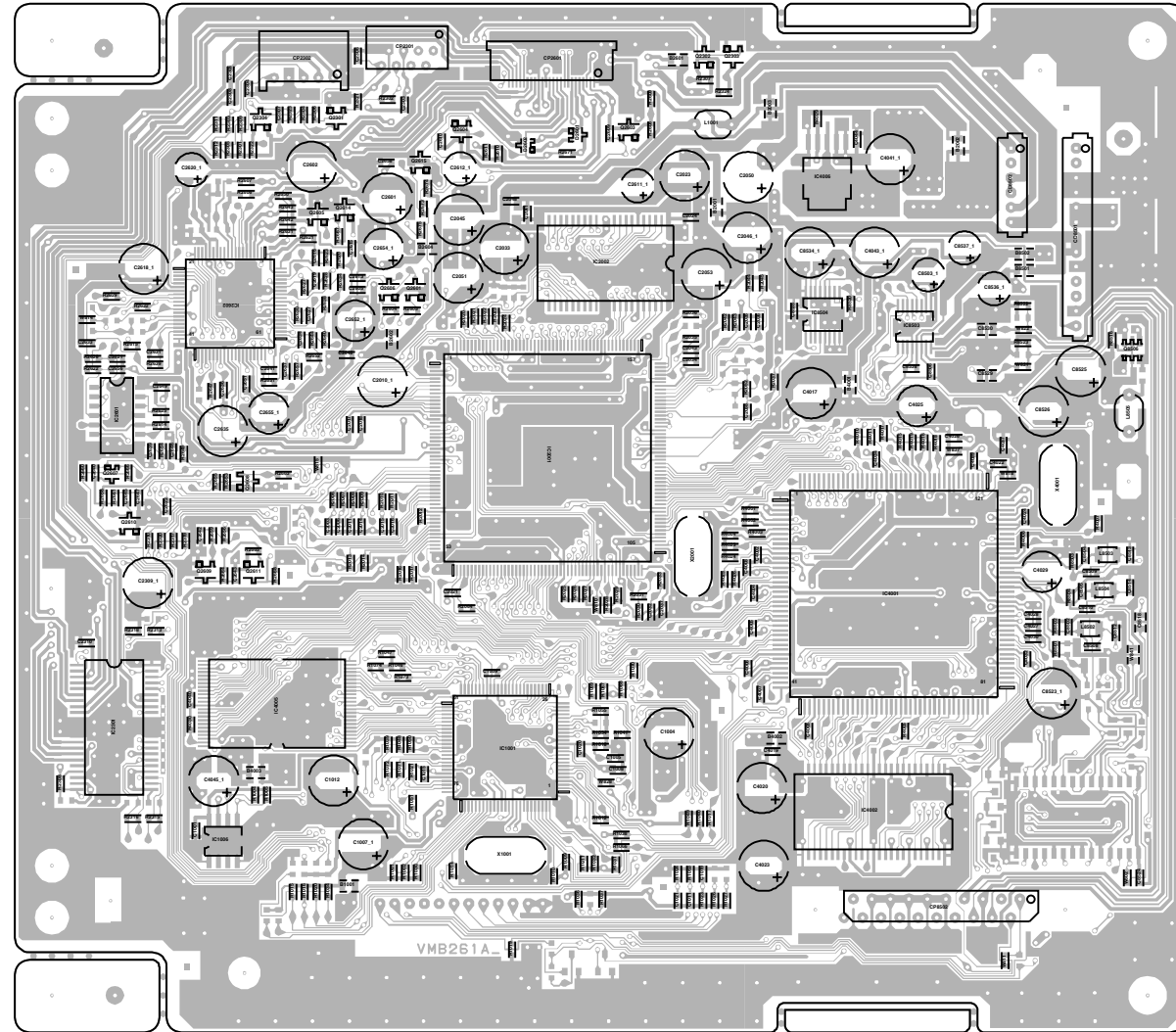

**(BOTTOM SIDE)**

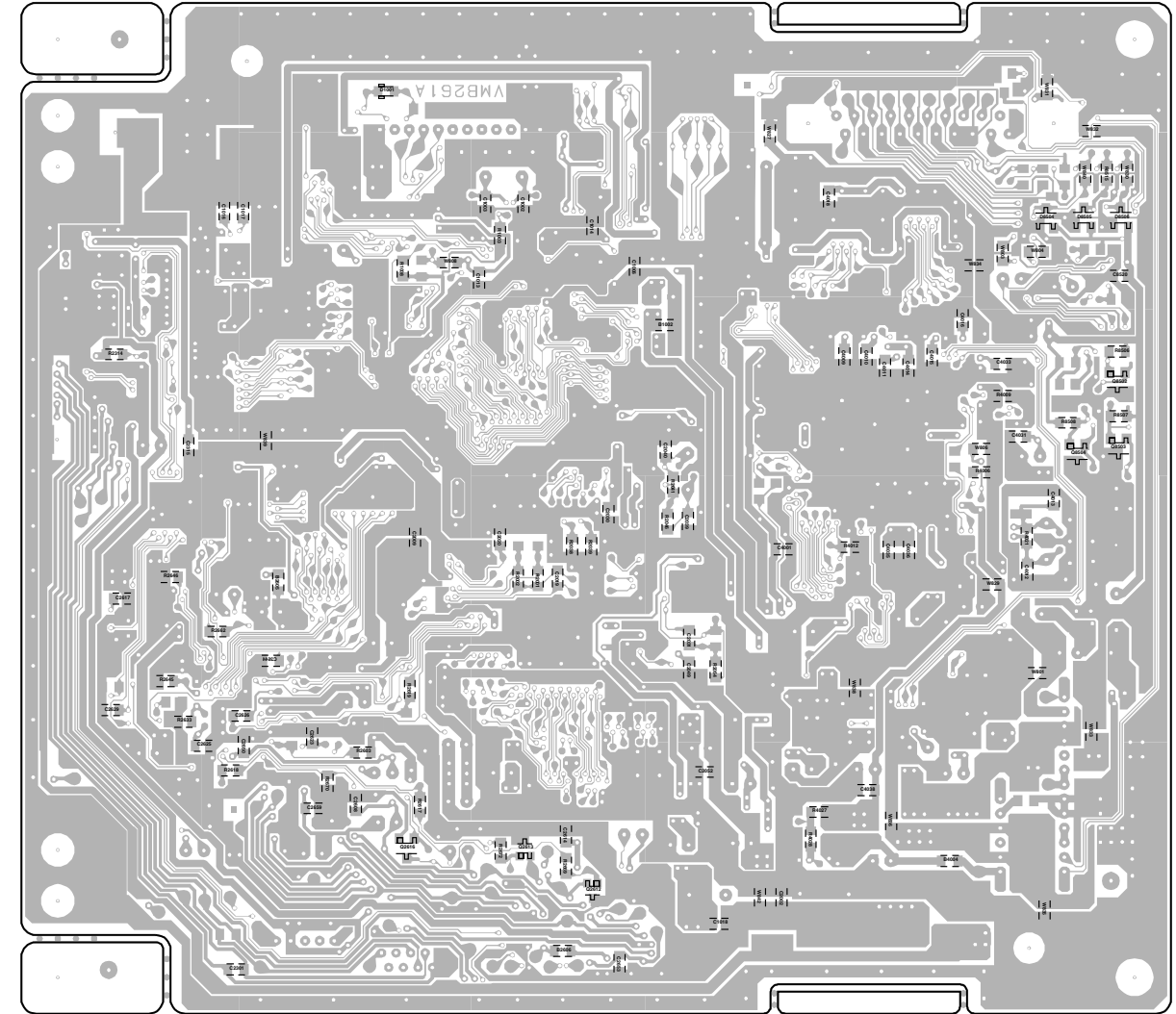

[AV/ CRT PCB PATTERN (INSERTED PARTS)]

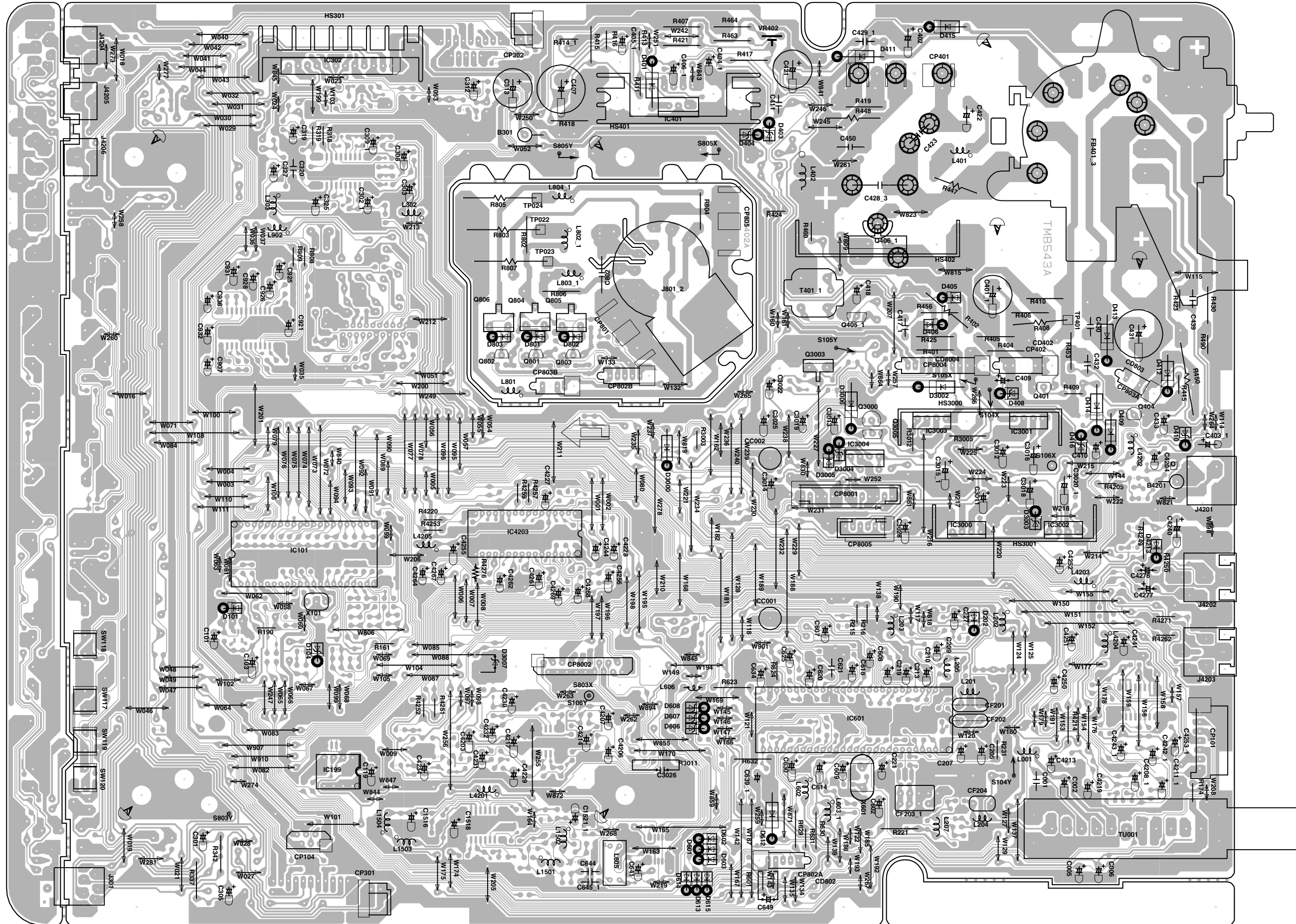

[AV/ CRT PCB PATTERN (CHIP MOUNTED PARTS)]

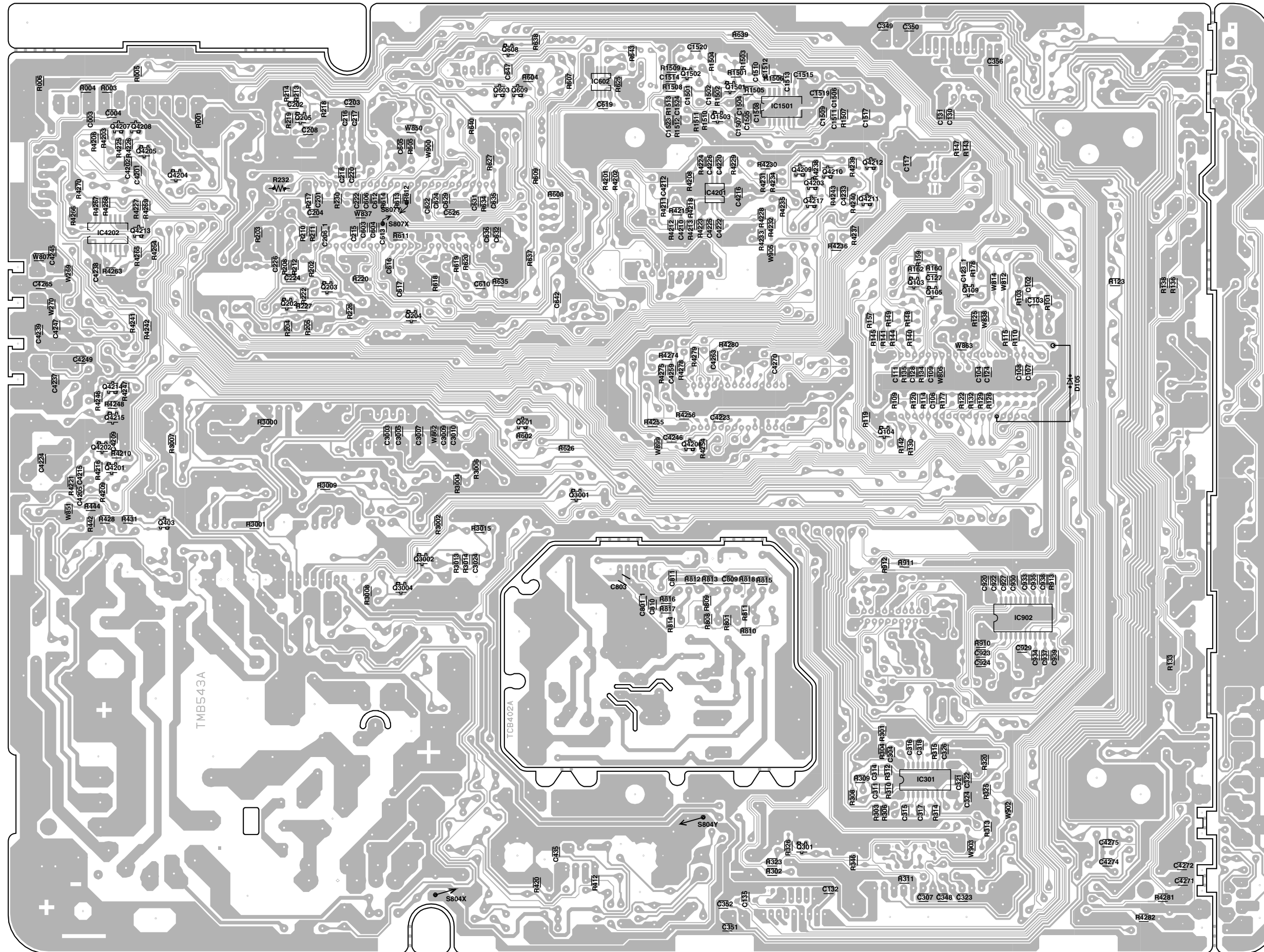

[POWER PCB PATTERN]

[OPERATION PCB PATTERN]

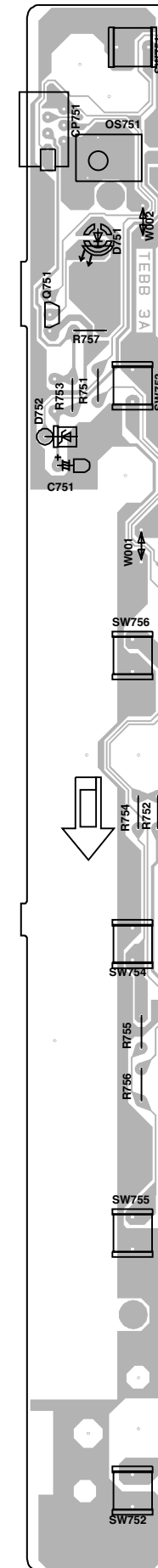
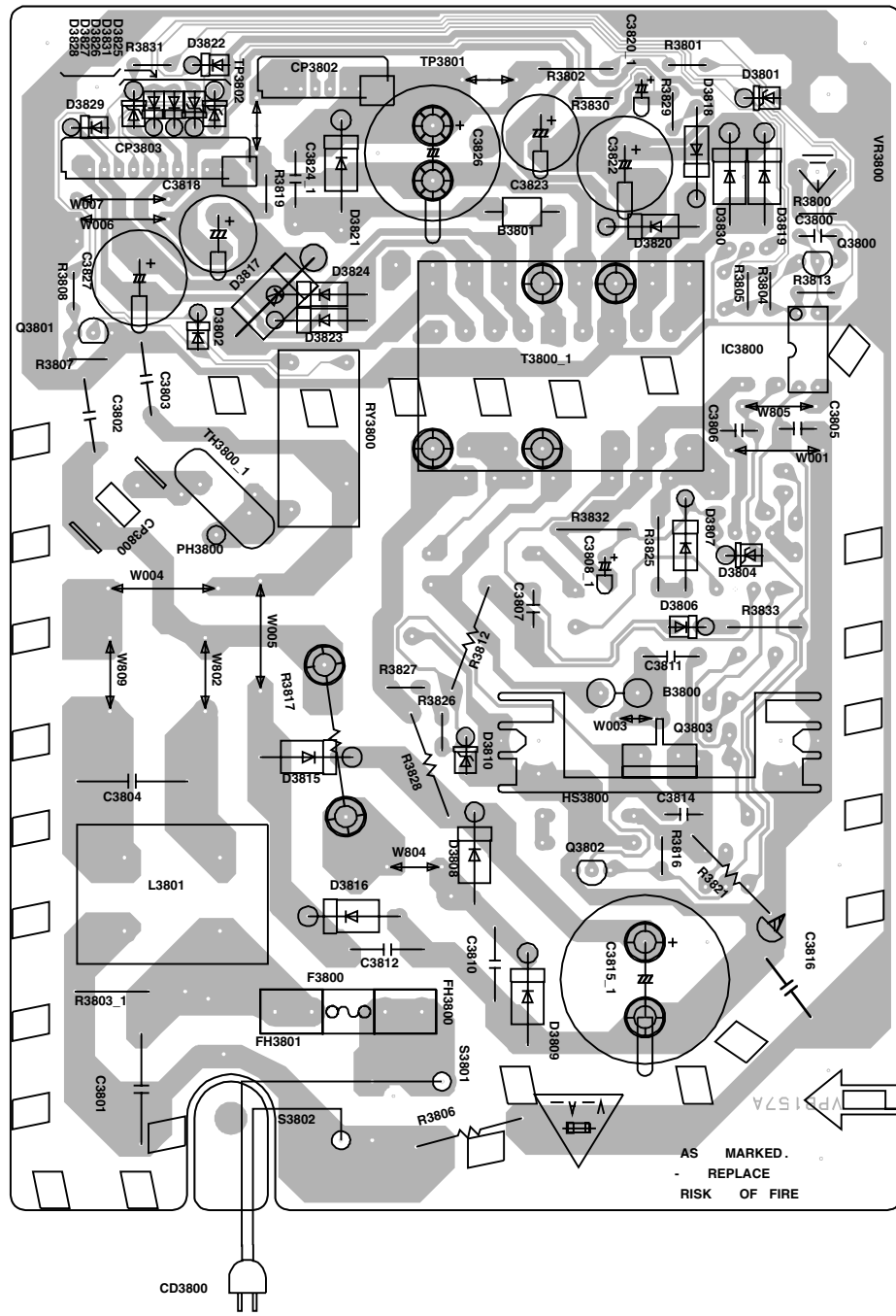



**WAVEFORMS**

**MPEG**

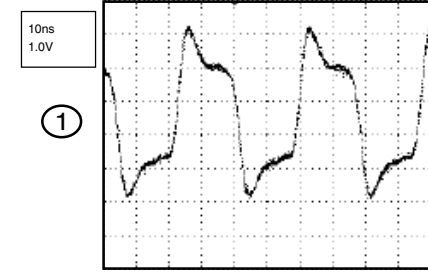

**SYSCON**

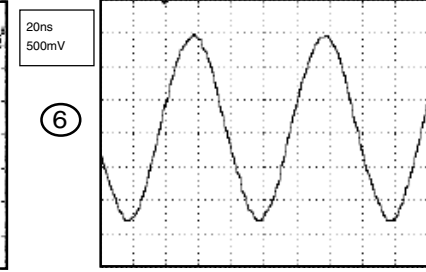

**MICON/TUNER**

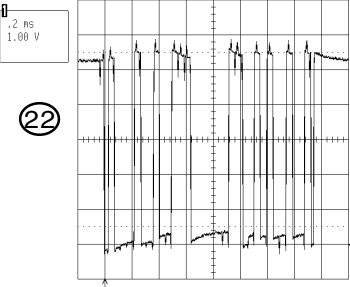

**VIF/SIF/CHROMA**

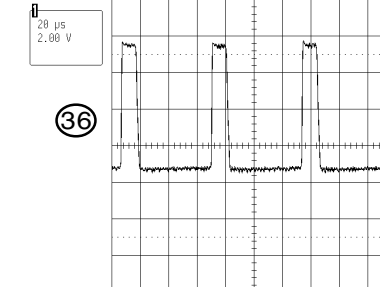
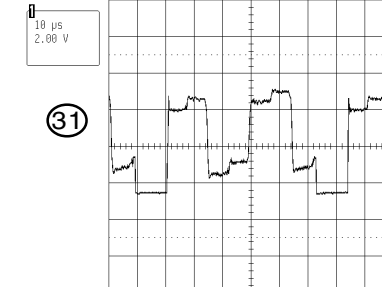
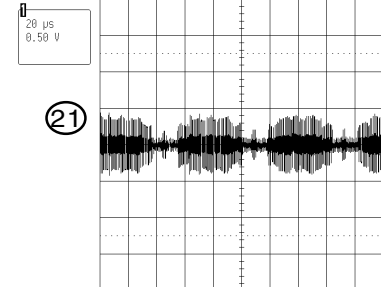

**MPEG**

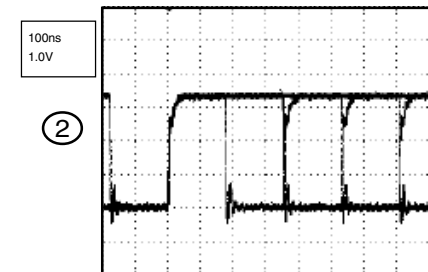

**DSP**

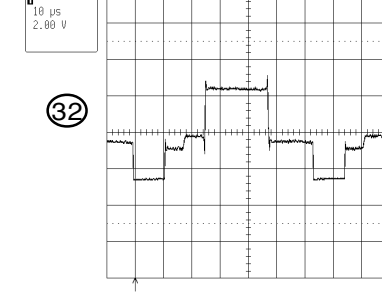
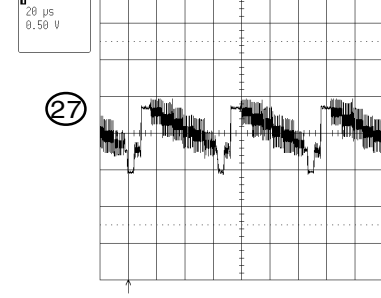
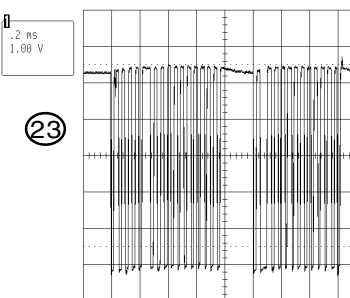
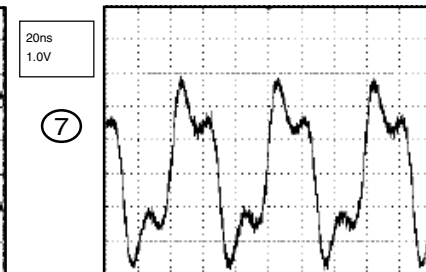

**SOUND AMP**

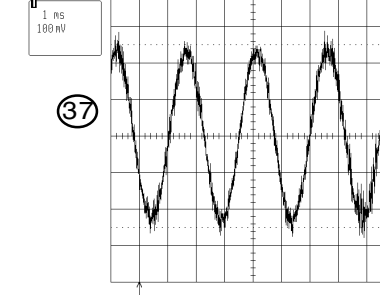

**MPEG**

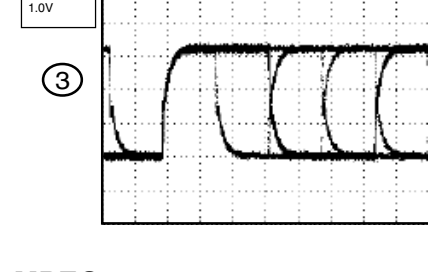

**DSP**

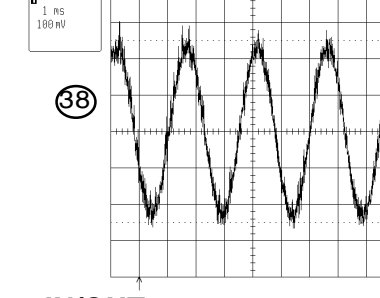
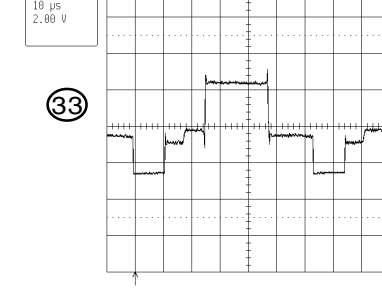
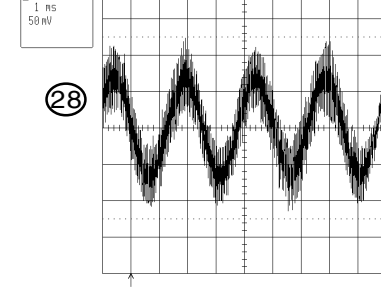
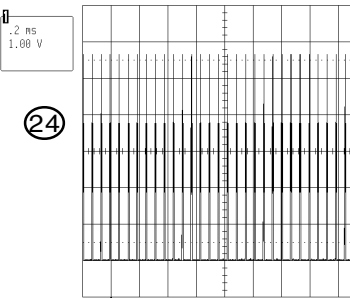
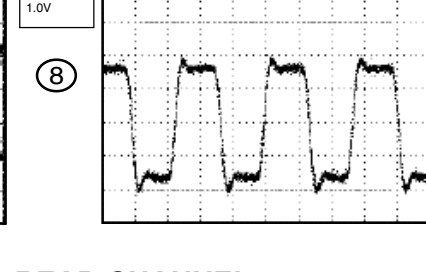

**MPEG**

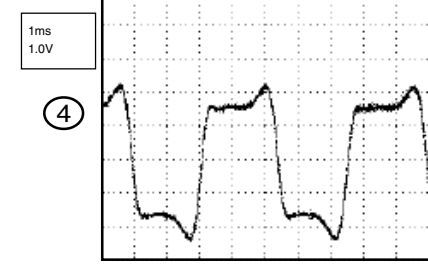

**READ CHANNEL**

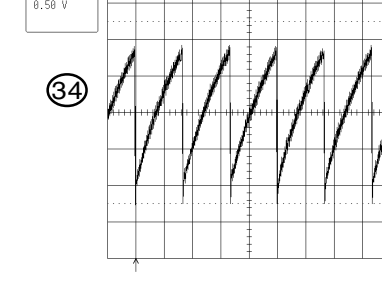
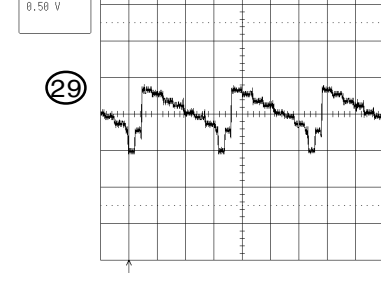
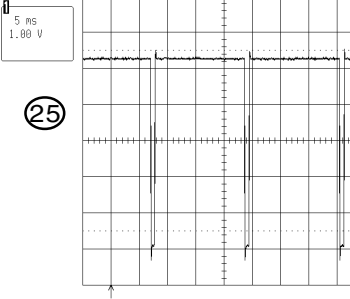
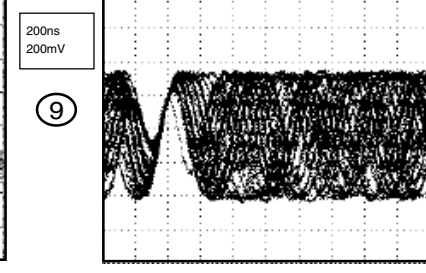

**IN/OUT**

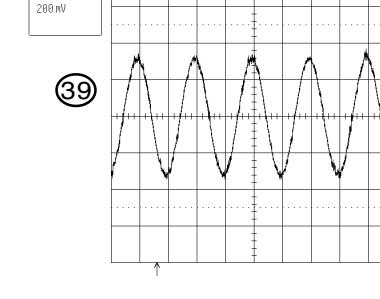

**MEMORY**

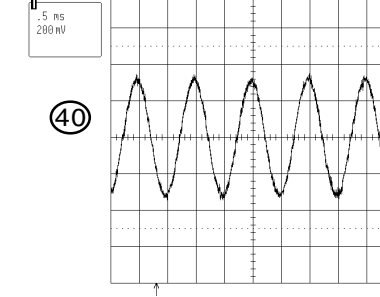
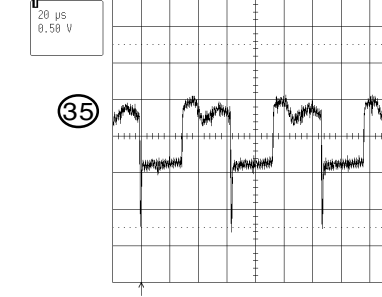
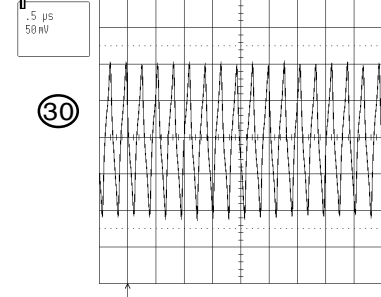
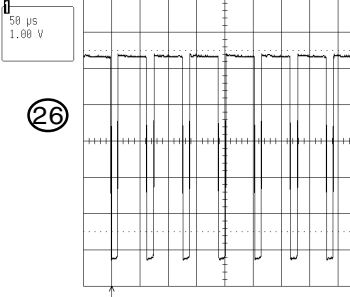
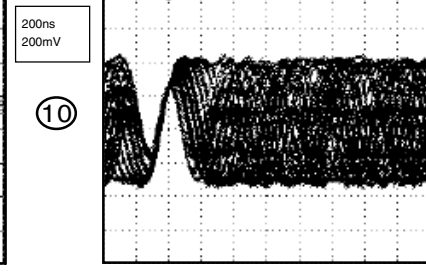
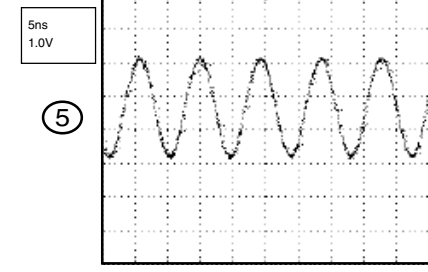

NOTE: The following waveforms were measured at the point of the corresponding balloon number in the schematic diagram.

NOTE: The following waveforms were measured at the point of the corresponding balloon number in the schematic diagram.

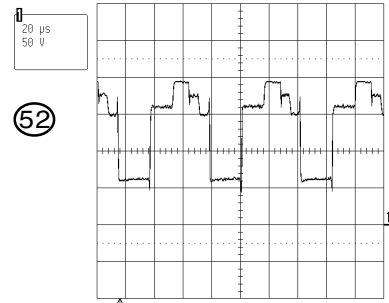
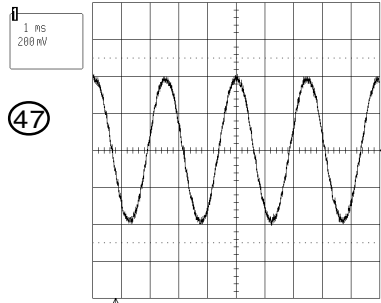
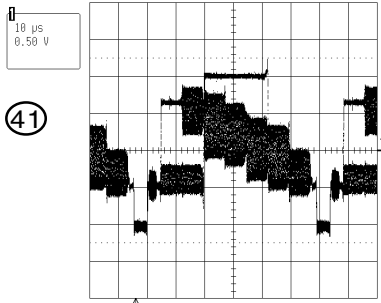

**AV SW**

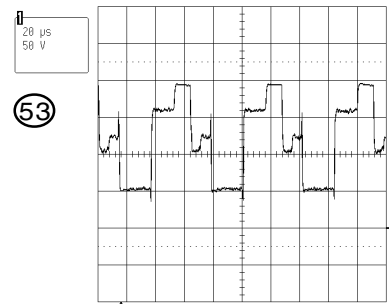
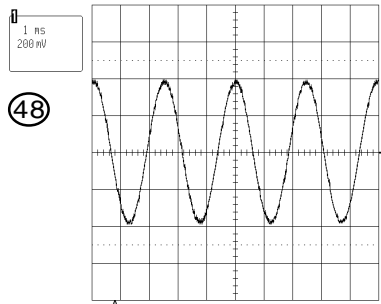
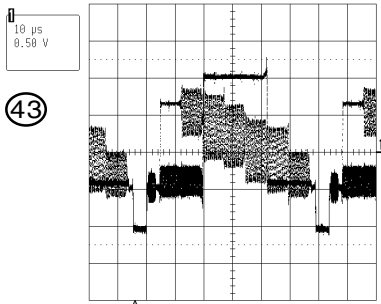

**DEFLECTION**

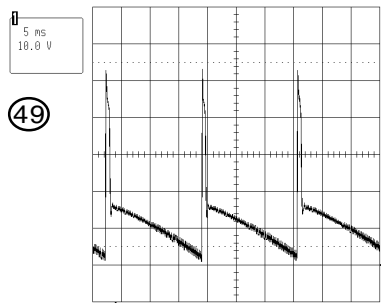
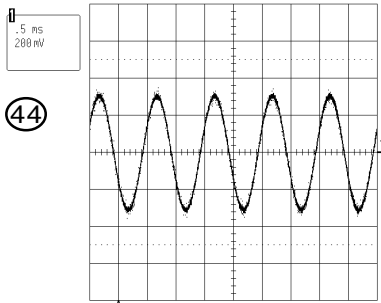

**TV POWER**

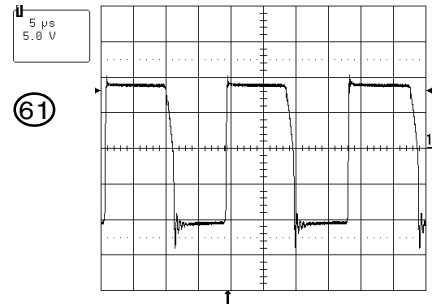
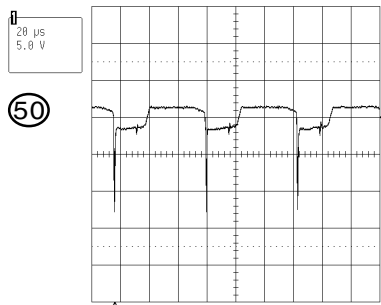
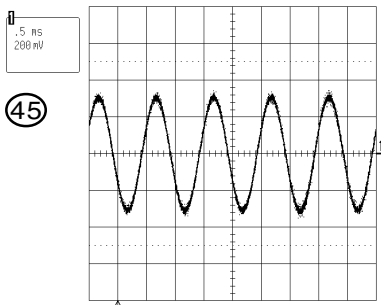
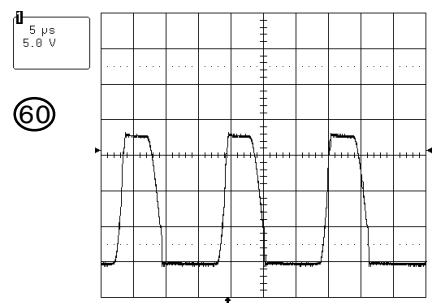

**STEREO**

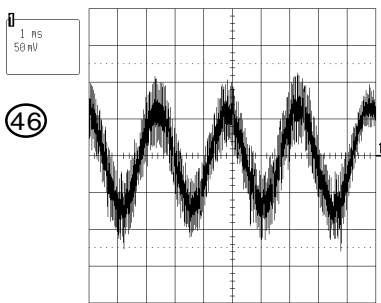

**CRT**

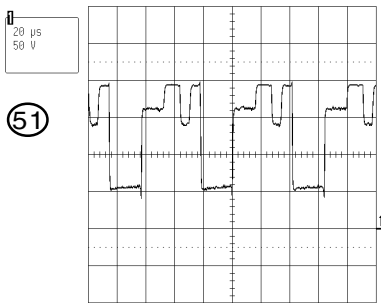

NOTE: The following waveforms were measured at the point of the corresponding balloon number in the schematic diagram.

# JVC SERVICE & ENGINEERING COMPANY OF AMERICA

## DIVISION OF JVC AMERICAS CORP.

<b>Head office</b> :	1700 Valley Road, Wayne, New Jersey 07470	(973)317-5000
<b>East Coast</b> :	10 New Maple Avenue, Pine Brook, New Jersey 07058	(973)396-1000
<b>Midwest</b> :	705 Enterprise St. Aurora, Illinois 60504	(630)851-7855
<b>West Coast</b> :	5665 Corporate Avenue, Cypress, California 90630	(714)229-8011
<b>Southwest</b> :	10700 Hammerly, Suite 105, Houston, Texas 77043	(713)935-9331
<b>Hawaii</b> :	2969 Mapunapuna Place, Honolulu, Hawaii 96819	(808)833-5828
<b>Southeast</b> :	1500 Lakes Parkway, Lawrenceville, Georgia 30243	(770)339-2582

## JVC CANADA INC.

<b>Head office</b> :	21 Finchdene Square Scarborough, Ontario M1X 1A7	(416)293-1311
<b>Vancouver</b> :	13040 Worster Court Richmond B.C. V6V 2B3	(604)270-1311

# JVC®